

Hoffman
CALIFORNIA-INTERNATIONAL FABRICS

PALETTE of the Season



A Walk in the Park
designed exclusively for Hoffman Fabrics by
The Gourmet Quilter

Finished Size: 59" x 67"

FREESHOP-131-Oak

Patchwork piecing:

When piecing it is good to use a ¼" seam allowance throughout, unless otherwise mentioned. Here is a video to see how you can achieve a ¼" seam allowance: <https://youtu.be/bdzlMEqAAbc>

Press seams as you go. Generally it is a good idea to press towards the darker coloured fabric although there are times when it is better to press to suit the piecing. An example of this is where we are joining strips that are already pieced, it is helpful to have the seams going in opposite directions so that they nestle together nicely and don't create bumps. The seams are more likely to meet at the joins better this way.

I like to trim my threads as I go, some sewing machines do this quite nicely, however not all! I suggest you trim the threads about ¼" away from where the stitching finished so that it doesn't just unravel, the extra little bit is surprisingly helpful with this.

Enjoy the quilt!

Applique:









The method I have used for the appliqué is as follows:

1. Iron the fabrics.
2. Trace the pattern pieces, using a pencil, on to paper-backed fusible webbing. The patterns are back to front because when you trace and use fusible web they will be reversed. The paper backed fusible webbing has glue on one side (rough texture) and is smooth on the other side. Trace on to the smooth side. Roughly cut out the pieces, not on the lines, and iron the glue side to the back side of the fabric pieces. Now cut out on the lines, with the paper attached.
3. Wiggle the pieces a little, this should loosen the paper, peel the paper off (there should now be glue on the back side of the fabric) and position the pieces on to the background fabric. Iron in place.
4. For this quilt, a machine blanket stitch works well or free-motion straight stitch close to the edge. I use the same colour for all the applique stitching, usually a dark charcoal colour.
5. With the applique patterns there is a 1" scale guide included so that you can see if your patterns are printing the correct size, computers and printers often print a different size to the original.



For printing purposes, the paper size used is US Letter size, however the printer should be set to print "actual size" even if you are using a slightly different size paper.

A Walk in the Park

This quilt is built in columns

Cutting		Quilt measures approx. 59" x 67"	Label
Fabric A - Light blue  Bluegrass	columns 2, 4 & 6 columns 2, 4 & 6 columns 2, 4 & 6 border 2 (needs joining) border 2 corners applique leaves	3 x 6½" x 10½" rectangles 6 x 6½" x 20½" rectangles 3 x 6½" x 12½" rectangles 5 x 5½" strips, width of fabric 4 x 5½" squares 3 x large oak leaves	A1 A2 A3 A4 A5
Fabric B - Medium blue  Big Sur	columns 1, 3 & 5 columns 1, 3 & 5 border 2 corners applique leaf	6 x 6½" x 20½" rectangles 3 x 6½" x 18½" rectangles 4 x 4" squares 1 x small oak leaf	B1 B2 B3
Fabric C - Dark  Stone	border 1 (needs joining) binding (needs joining) applique birds	5 x 2" strips, width of fabric 7 x 2½" strips, width of fabric 2 x birds	C1 C2
Fabric D - Dark aqua  Sea Cliff	border 3 (needs joining) applique leaves applique leaves applique leaves applique bird	7 x 2½" strips, width of fabric 3 x small maple leaves 3 x medium maple leaves 2 x large maple leaves 1 x bird	D1
Fabric E - Toast  Toast	3 x tree trunks 6 x branches border 2 corners applique squirrel body	4 x 2½" strips, width of fabric 6 x 6½" x 8½" rectangles 4 x 5½" squares 2 x squirrel bodies	E1 E2 E3
Fabric F - Biscuit  Biscuit	9 x branches applique squirrel tails	9 x 6½" x 8½" rectangles 2 x squirrel tails	F1
Fabric G - Medium aqua  Juneau	applique leaves	4 x small oak leaves 7 x medium oak leaves 6 x large oak leaves	G
Fabric H - Light green  Sprout	applique leaves	2 x small maple leaves 1 x medium maple leaf 5 x large maple leaves	H
Fabric J - Dark grey  Smoke	applique leaves applique bird applique squirrel body	2 x small oak leaves 2 x medium oak leaves 3 x large oak leaves 1 x applique bird 2 x squirrel bodies	J

A Walk in the Park

Cutting continued		Quilt measures approx. 59" x 67"	Label
Fabric K - Medium grey  December	applique leaves squirrel tail	2 x small maple leaves 3 x medium maple leaves 1 x large maple leaf 1 x squirrel tail	K
Fabric L - Dark green  Pine	applique leaves	1 x medium maple leaf 1 x small maple leaf 2 x medium oak leaves 2 x large oak leaves	L
Fabric M - Light grey  Fog	applique leaves	2 x small oak leaves 1 x medium oak leaf 1 x large oak leaf	M
paper-backed fusible web <i>Please note:</i> there are a total of 60 leaves in assorted sizes and directions. The numbers listed are those shown on the quilt however you may prefer a different assortment.	applique leaves applique birds applique squirrel bodies applique squirrel tails	8 x small maple leaves 8 x medium maple leaves 8 x large maple leaves 9 x small oak leaves 12 x medium oak leaves 15 x large oak leaves 4 x applique birds 3 x applique squirrel tails 3 x applique squirrel bodies	
Backing		67" x 75"	
Batting		67" x 75"	

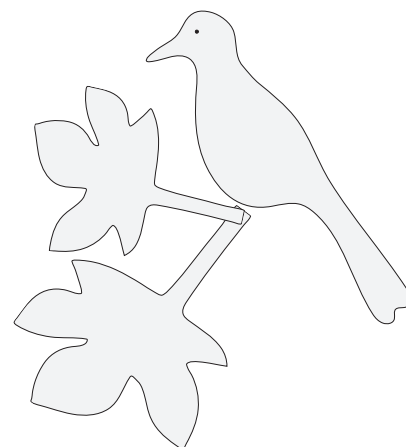
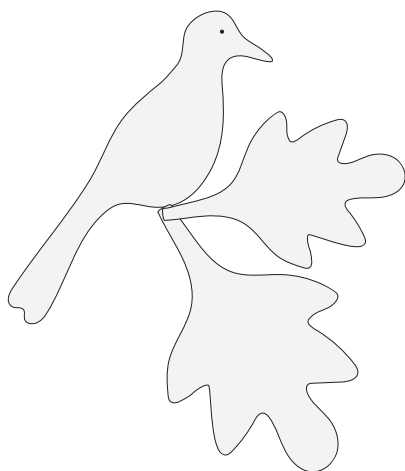

A Walk in the Park

Piecing:

The quilt is made in vertical columns. Looking at the diagrams below, make the vertical columns. There are 3 each of two different columns, A and B.

The pieced columns should measure 6½" wide by 50½" high.

The tree trunks that sit between the pairs of columns are simply long strips that measure 2½" wide by 50½" long.

Make Column A:

It is a good idea to mark a diagonal line ready for stitching on one end of the **E2** and **F1** rectangles, this can be done by folding over a corner so the edges sit together and fingerpress a diagonal line.

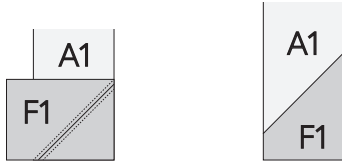

Lay the **F1** over the lower edge of **A1**, right sides together, and stitch along the diagonal line.

Trim away the corner and press seam toward **F1**.

(If you would like to utilise the trimmed away corners for another delicious project, you could draw a second line ½" away from the diagonal line (as shown in the diagram) and stitch along that as well.

When you trim away the corners, trim between the 2 stitched lines.)

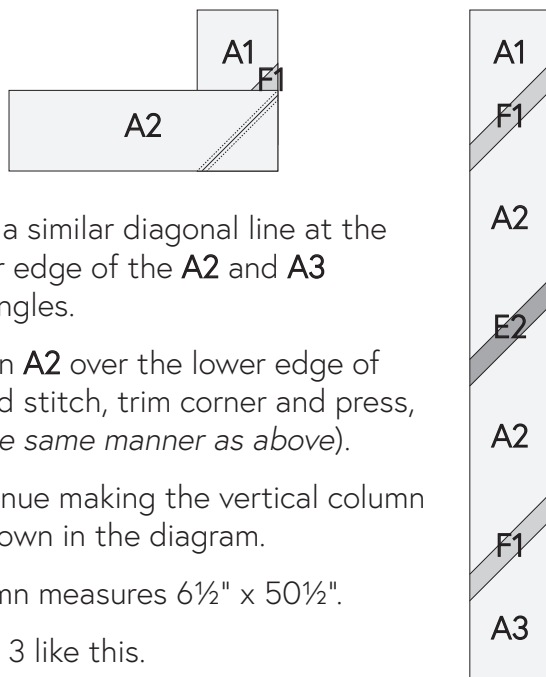

Mark a similar diagonal line at the upper edge of the **A2** and **A3** rectangles.

Lay an **A2** over the lower edge of **F1** and stitch, trim corner and press, *(in the same manner as above)*.

Continue making the vertical column as shown in the diagram.

Column measures 6½" x 50½".

Make 3 like this.

Make Column B:

Column B is made in a similar manner to column A, but the diagonals go in the opposite direction and there are only 2 branches.

Mark a diagonal line ready for stitching on one end of the **E2** and **F1** rectangles, this can be done by folding over a corner so the edges sit together and fingerpress a diagonal line.

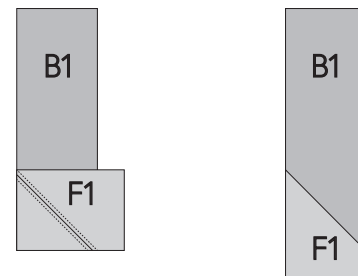

Lay the **F1** over the lower edge of **B1**, right sides together, and stitch along the diagonal line.

Trim away the corner and press seam toward **F1**.

Mark a similar diagonal line at the upper edge of the **B2** and **B1** rectangles.

Lay a **B2** over the lower edge of **F1** and stitch, trim corner and press, *(in the same manner as previously)*.

Continue making the vertical column as shown in the diagram.

Column measures 6½" x 50½".

Make 3 like this.

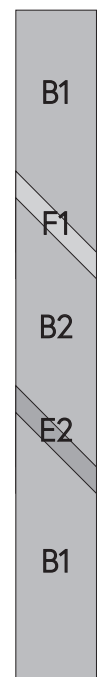

A Walk in the Park

Make the tree trunks:

Join together the **E1** strips into one long length then cut them into three trunks to measure the same as the columns - 50½" long.

Join the vertical columns:

The branch columns are joined into three sets of column B/tree trunk/column A. Then join these three trees together - as shown in diagram.

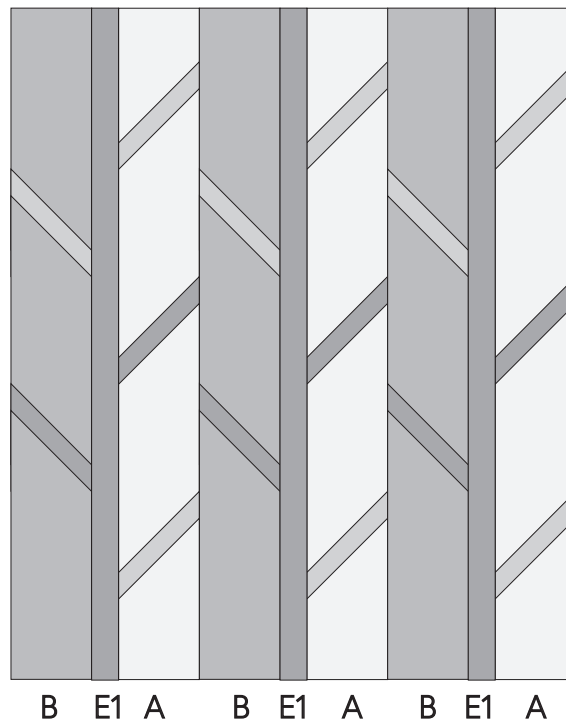

Add the borders:

Border 1:

Join the border **C1** strips together into one long length.

Measure the length of the quilt, in 3 separate places, take an average of the 3 measurements and cut the 2 side borders that length.

Attach the 2 sides, press the seams into the border.

Measure again the same way across the quilt, including the added side borders, cut the top and bottom borders that length. Attach the top and bottom borders and press.

A Walk in the Park

Add the borders: (see diagram on next page)

Border 2:

Make the 4 x border corners:

Mark a diagonal line on the back of the **E3** & **B3** squares.

Lay the **E3** right sides together with **A5** and stitch along the diagonal line.

Trim away the corner and press seam toward **E3**.

(If you would like to utilise the trimmed away corners for another delicious project, you could draw a second line 1/2" away from the diagonal line (as shown in the diagram) and stitch along that as well.

When you trim away the corners, trim between the 2 stitched lines.)

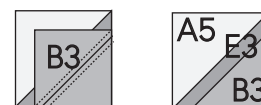
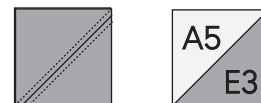
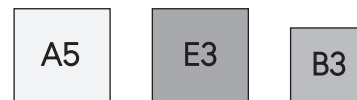

Lay the **B3** right sides together with **E3** and stitch along the diagonal line, trim & press as previously. The 4 x border corner squares measure 5 1/2" square.

Join the border **A4** strips together into one long length.

Measure the length of the quilt, in 3 separate places, take an average of the 3 measurements and cut the 2 side borders that length. Attach the 2 sides, press the seams into the border.

Measure again the same way across the quilt, excluding the added side borders, cut the top and bottom borders that length plus 1/2" seam allowance.

Attach the border corner squares to each end.

Attach these top and bottom borders and press.

Border 3:

Join the **D1** border strips together into one long length.

Repeat the same method as for Border 1.

All the borders are on!

Applique:

At this stage you can choose if you would like to add all the applique now, or layer, baste and quilt the quilt, then add the applique.

There is no right or wrong way, just a personal preference.

The method for the applique is the same for both options.

If the applique is done after/during quilting, the stitching will go through all layers, so you will see the stitching on the back. It can also become part of the quilting.

Either before, or after quilting, position the birds and leaves on the quilt.

Iron in place.

Applique stitch around the shapes.

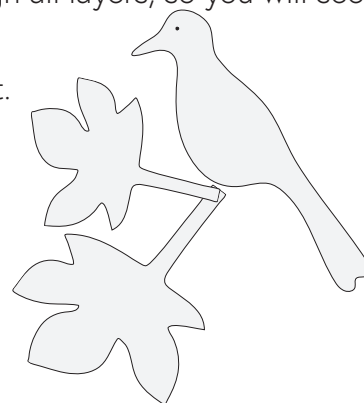
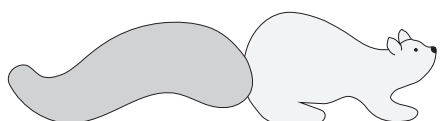

A Walk in the Park

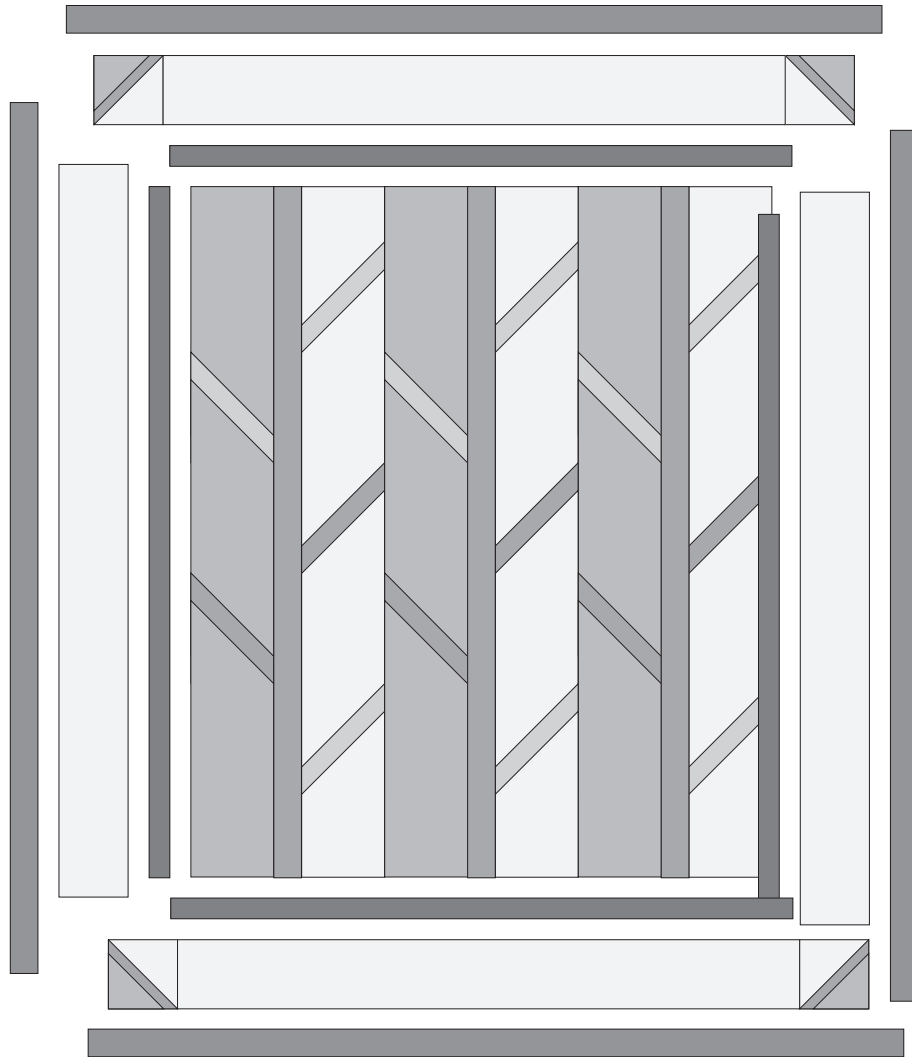

This means the quilt top is now finished! Now for some quilting!

Layering and Basting:

The backing and batting should be larger than your quilt top, maybe allow about 4" all round. Layer the quilt backing, batting and quilt top and baste ready for quilting. If you are using safety pins for basting, they should be approximately 4" apart, all over the quilt.

Quilt the quilt.

An all over free-motion quilting design works well.

However, you may prefer to use a walking foot to do straight lines, or do a different style of quilting! The straight lines can be stitched just a little away from the seam lines, or applique, approximately $\frac{1}{8}$ " - $\frac{1}{4}$ " away.

The quilt should have a fairly even amount of quilting all over to allow it to sit well.

Trim the edges of the batting and backing level with the edge of the quilt top.

The quilt is now ready for binding.

A Walk in the Park

Binding:

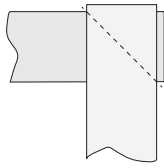

1. Join the binding strips, right sides together, diagonally into one long strip.

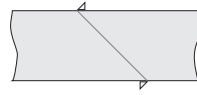

2. Press the seams open and trim away the little ears.

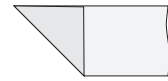

3. Trim the selvedge away and press the corner to the wrong side so the raw edges are level.



4. Fold the binding in half along the length, wrong sides together.

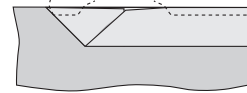

5. ******(see below) Attach the binding to the front of the quilt, raw edges even, using a $\frac{1}{4}$ " seam allowance. Starting along one side, from the point of the binding edge, stitch along for approx. 1" then stop and finish off.

Start stitching again approx. 3" further along.

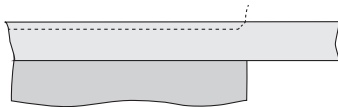

6. To form a mitred corner in the binding, stop stitching $\frac{1}{4}$ " before the end of the side and stitch diagonally out through the corner. Remove quilt and clip threads.

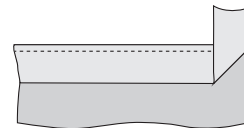

7. Turn the quilt so that it is ready to stitch the next side, fold back the binding diagonally away from you, so that the diagonal fold goes through the corner of the quilt.

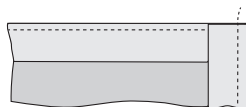

8. Fold the binding down towards you so that the folded edge is even with the edge of the quilt. Stitch from the folded edge along the side of the quilt.

Repeat this process at each corner.

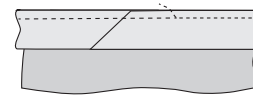

9. When you arrive at the starting point, trim the excess binding away, allowing enough to tuck inside the open end and stitch along until you meet the starting stitching.

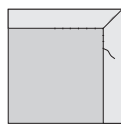

10. Fold the binding to the back of the quilt and slip stitch in place. The folded edge should just cover the machine stitched line. The corners should be folded into mitres and stitched in place.

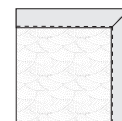

****** If you would prefer to attach your binding entirely by machine, start off by stitching the binding to the back of the quilt and continue as above. Fold the binding to the front of the quilt and machine stitch in place, stitching close to the folded edge of the binding.

Congratulations! You have finished A Walk in the Park quilt!

A Walk in the Park

A Walk in the Park

Applique shapes

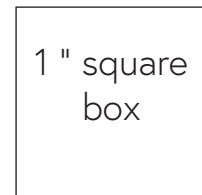
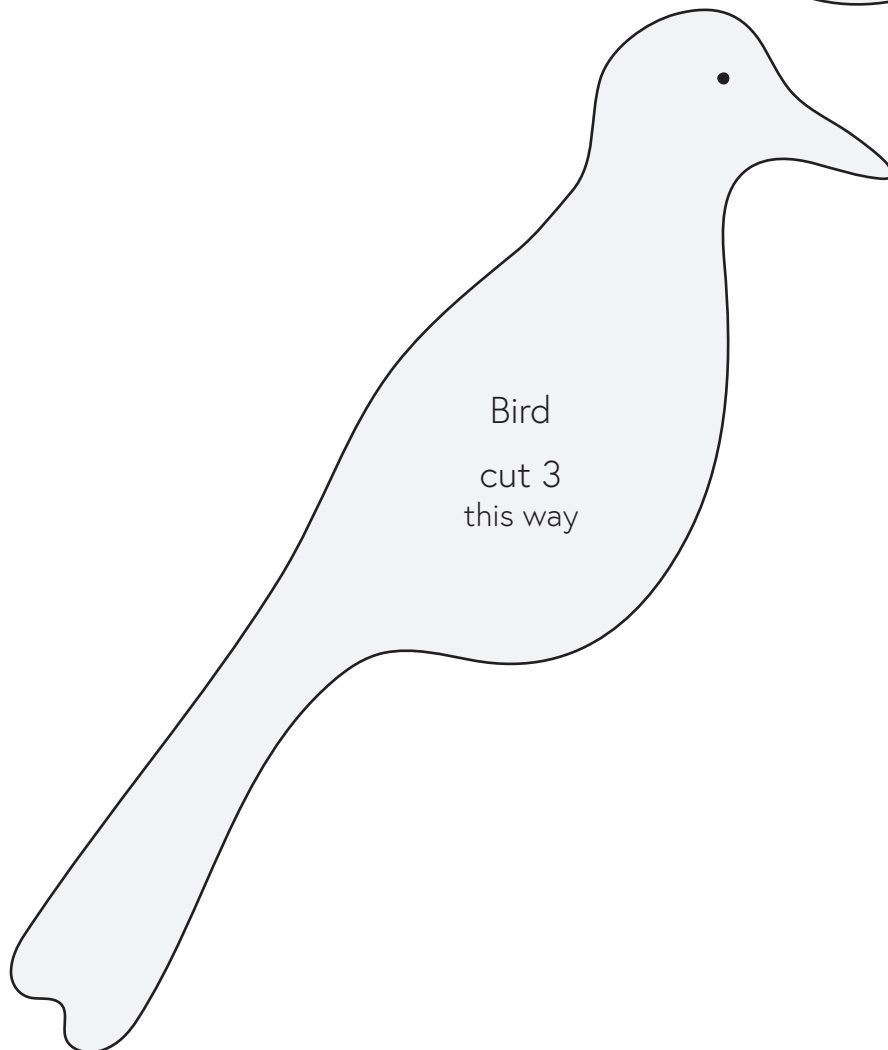
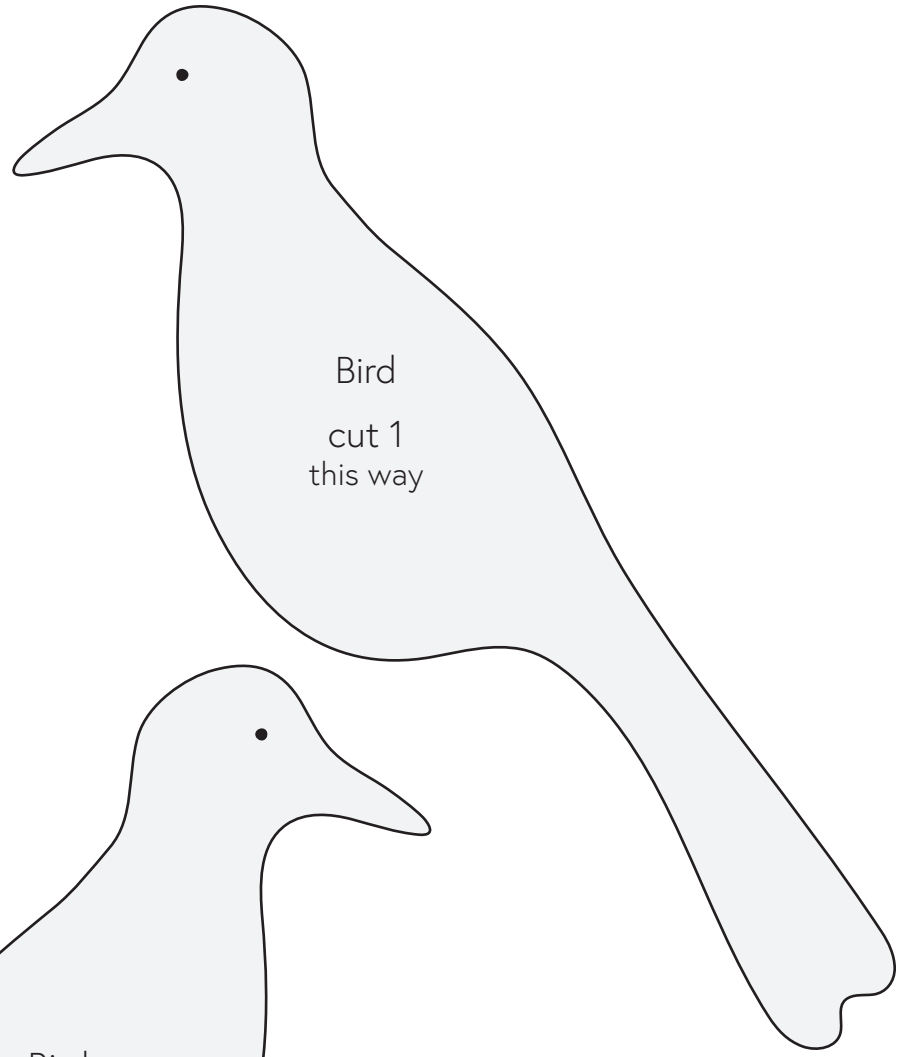

Measure the 1" square box to check that your pattern is printing the correct size.

A Walk in the Park

A Walk in the Park

Applique shapes

Maple leaf - large
cut a total of 8 large
leaves in assorted
directions

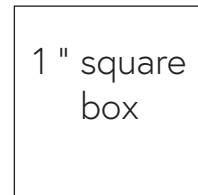
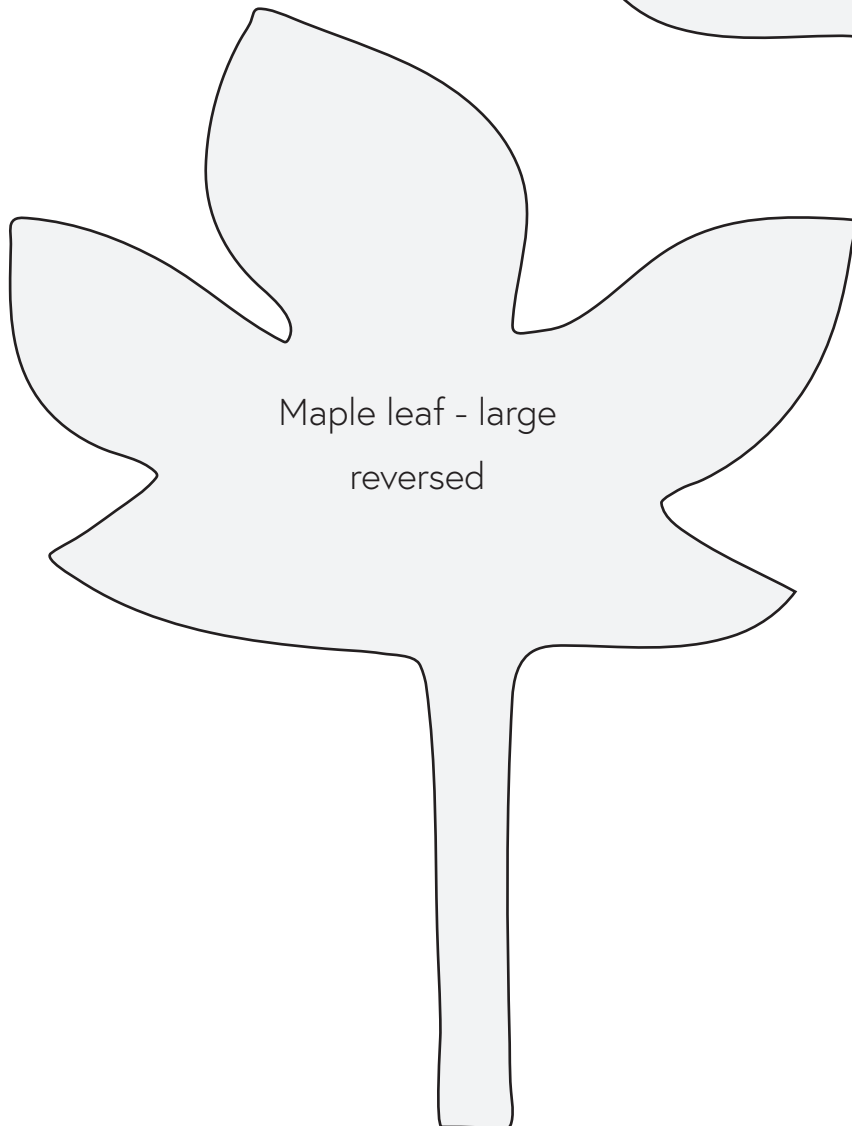
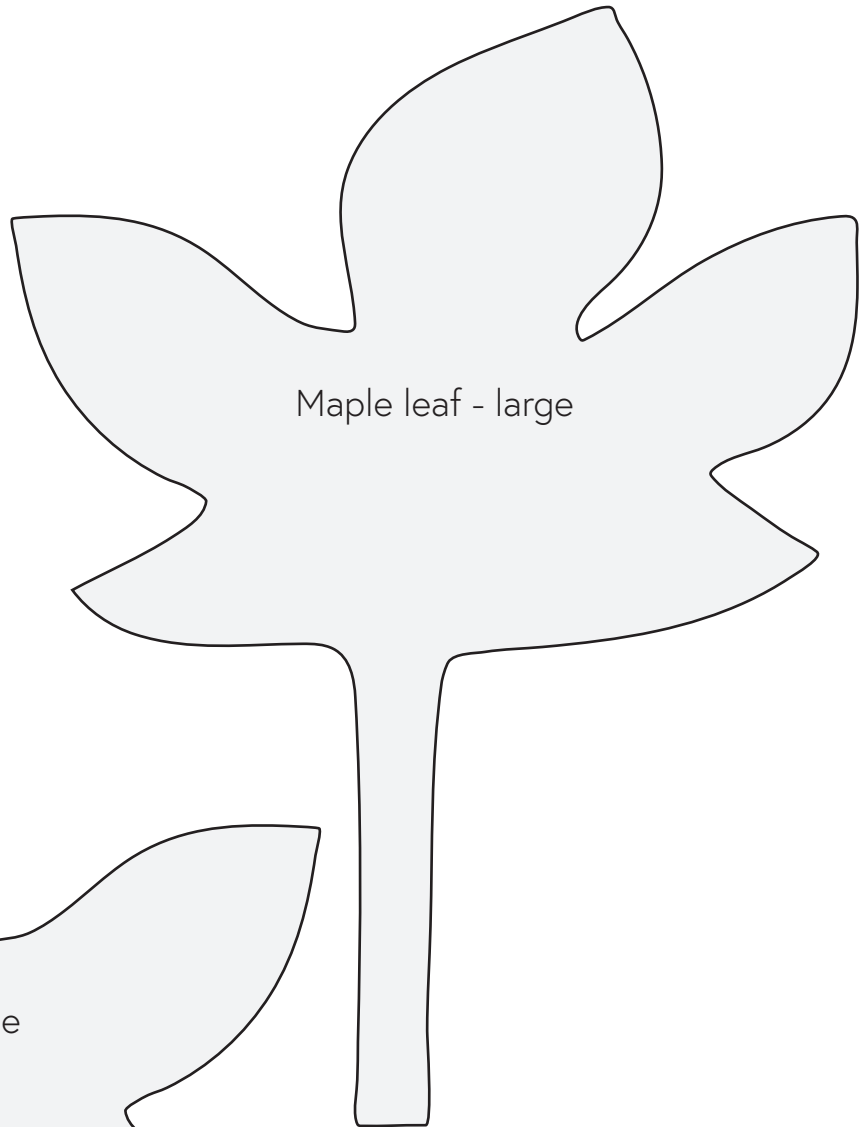

Measure the 1"
square box to check
that your pattern is
printing the
correct size.

A Walk in the Park

A Walk in the Park

Applique shapes

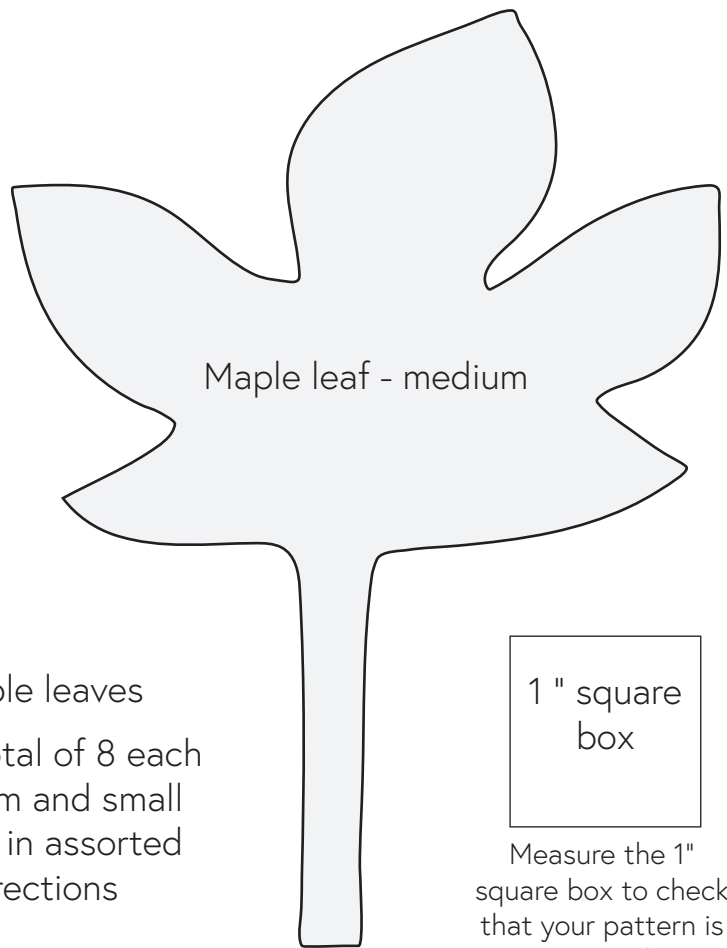
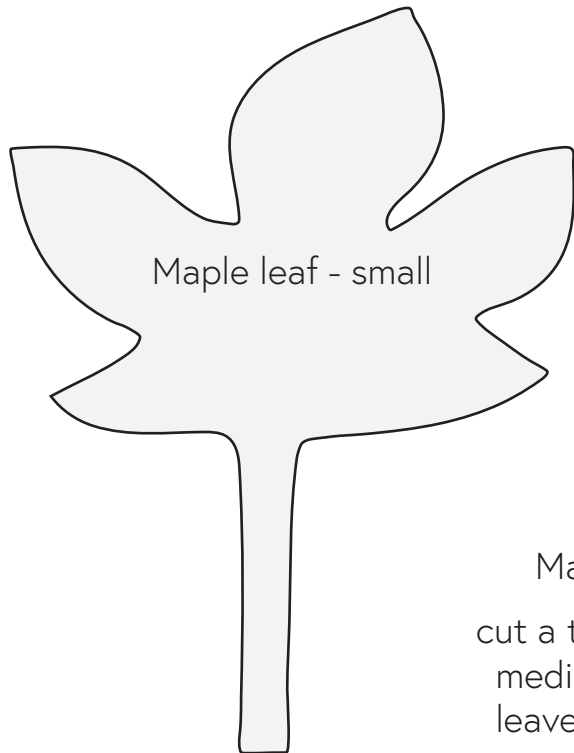

Maple leaves
cut a total of 8 each
medium and small
leaves in assorted
directions

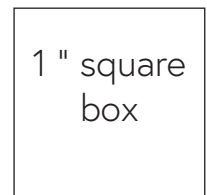

Measure the 1"
square box to check
that your pattern is
printing the
correct size.

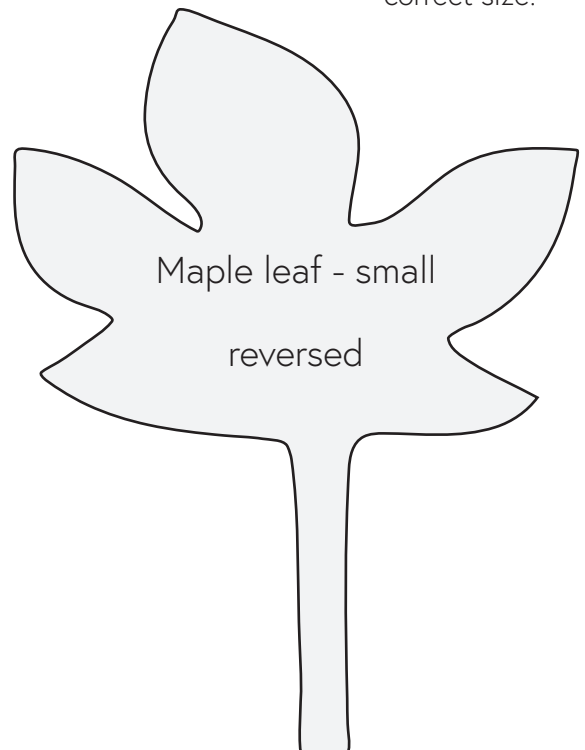
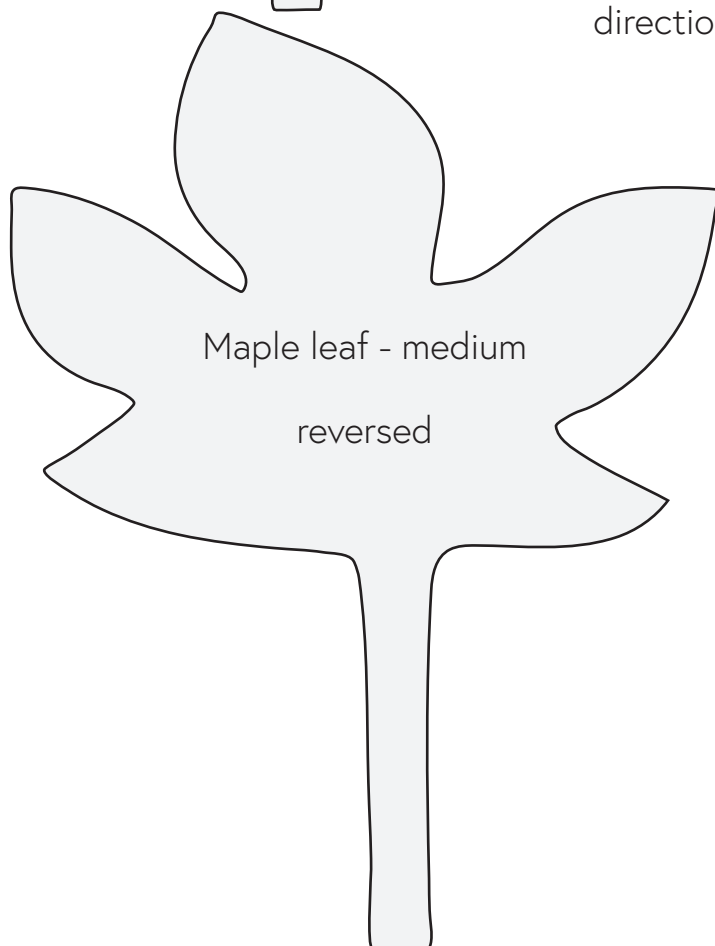

A Walk in the Park

A Walk in the Park

Applique shapes

Oak leaf - large
cut a total of 11 large
leaves in assorted
directions

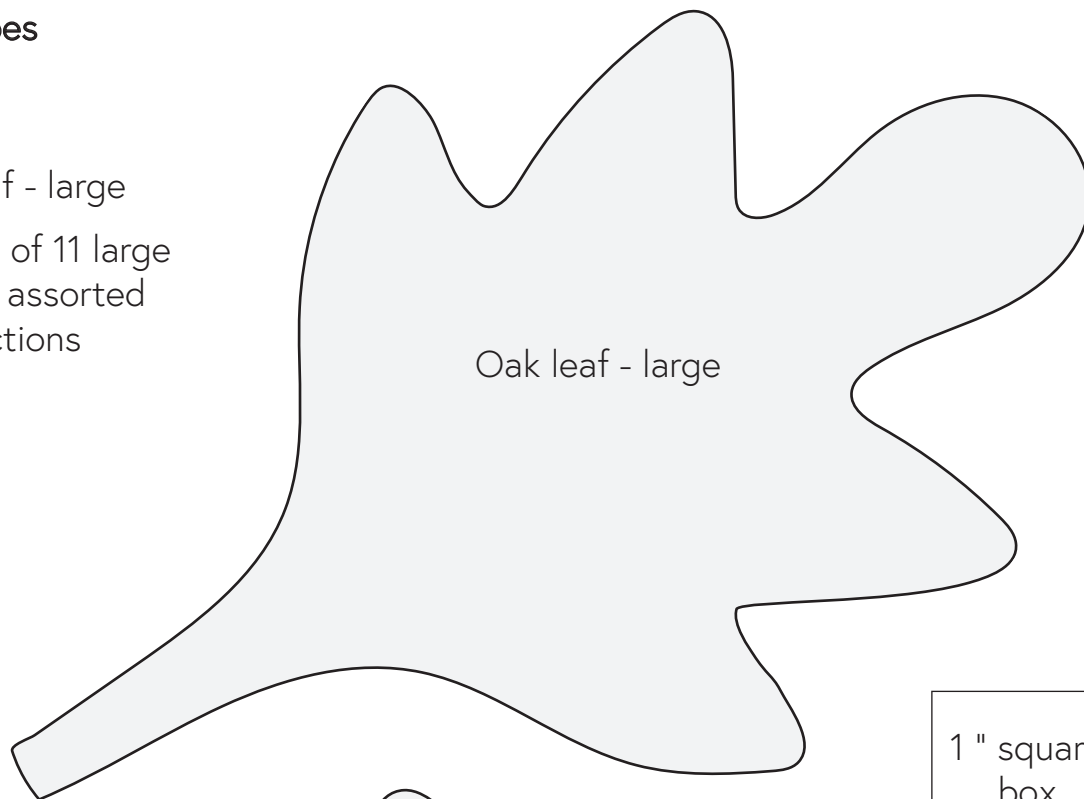

Oak leaf - large

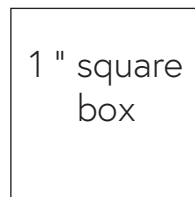

Measure the 1"
square box to check
that your pattern is
printing the
correct size.

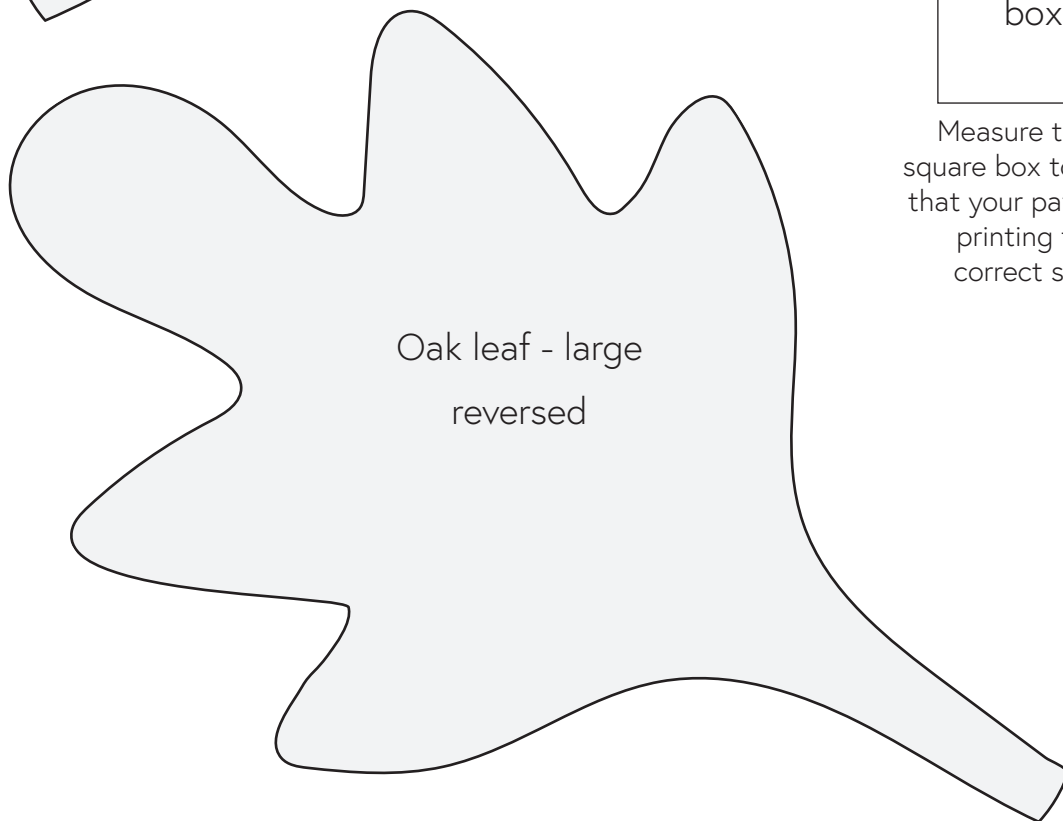

Oak leaf - large
reversed

A Walk in the Park

A Walk in the Park

Applique shapes

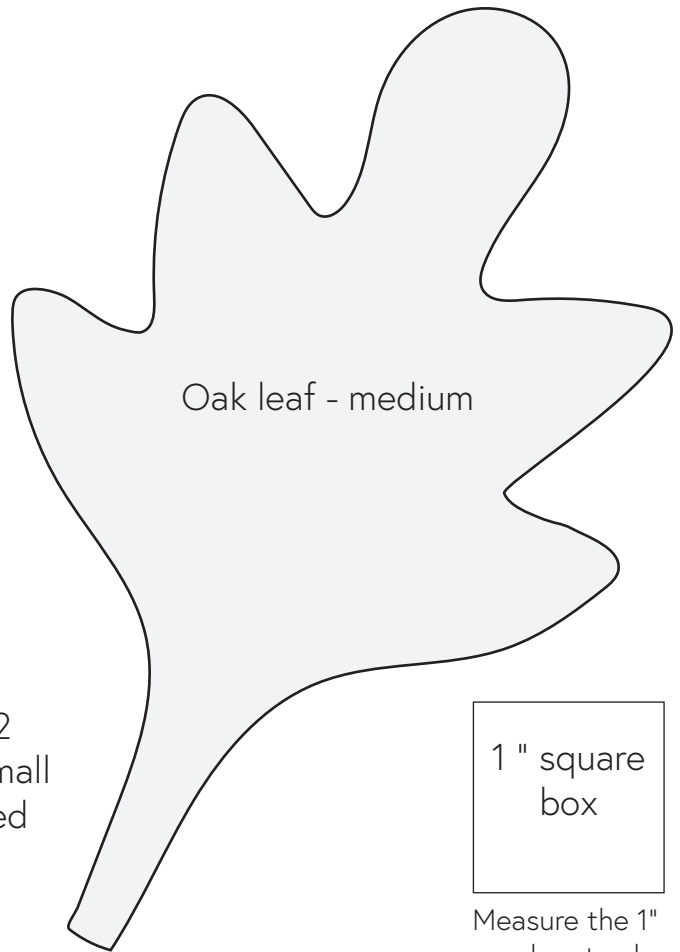

Oak leaves
cut a total of 12
medium and 13 small
leaves in assorted
directions

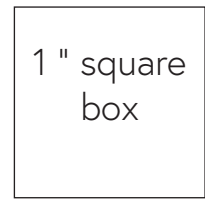

Measure the 1"
square box to check
that your pattern is
printing the
correct size.

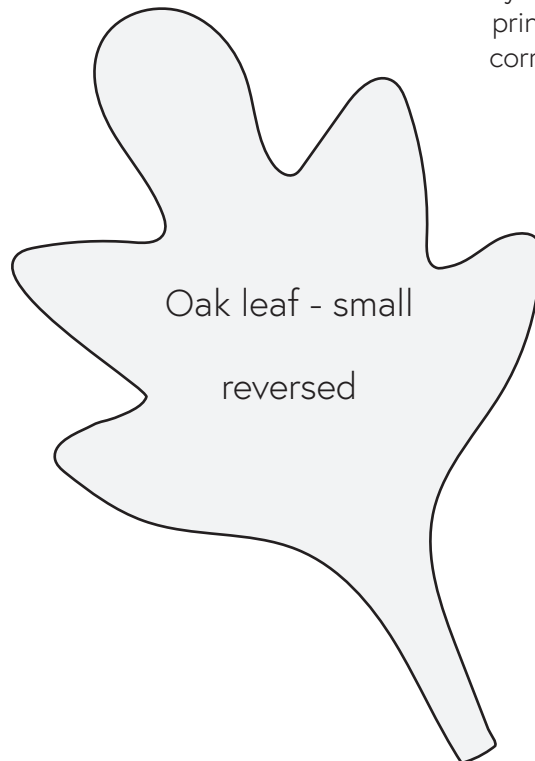
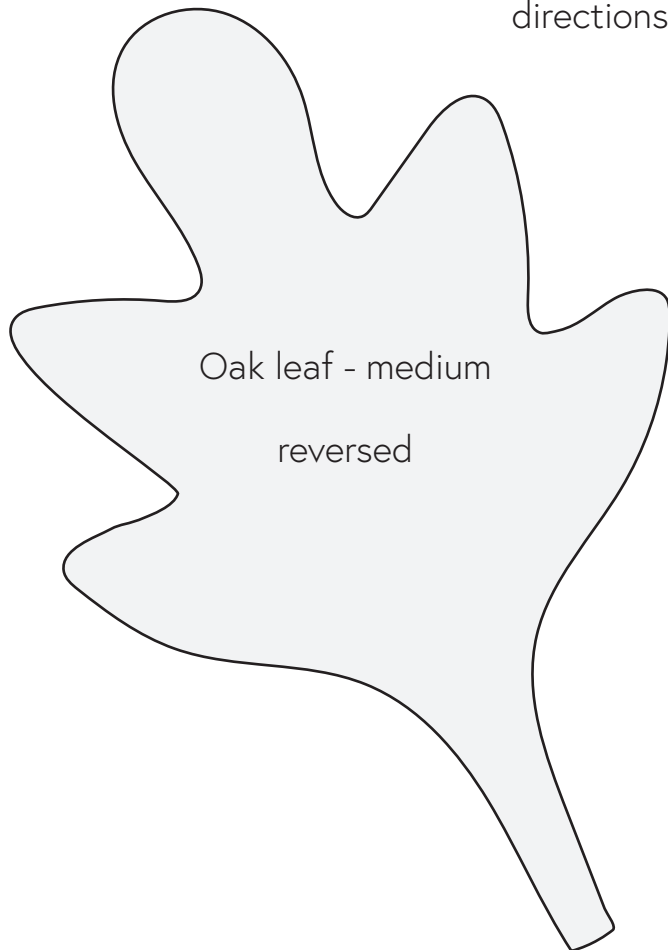

A Walk in the Park

A Walk in the Park

Applique shapes

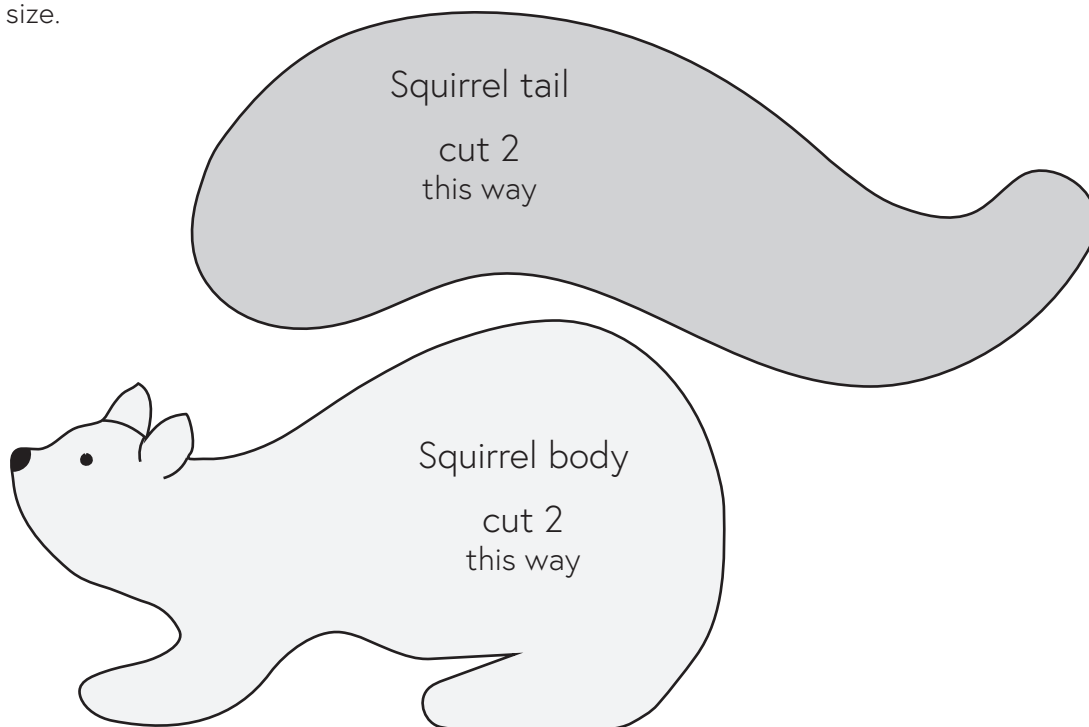
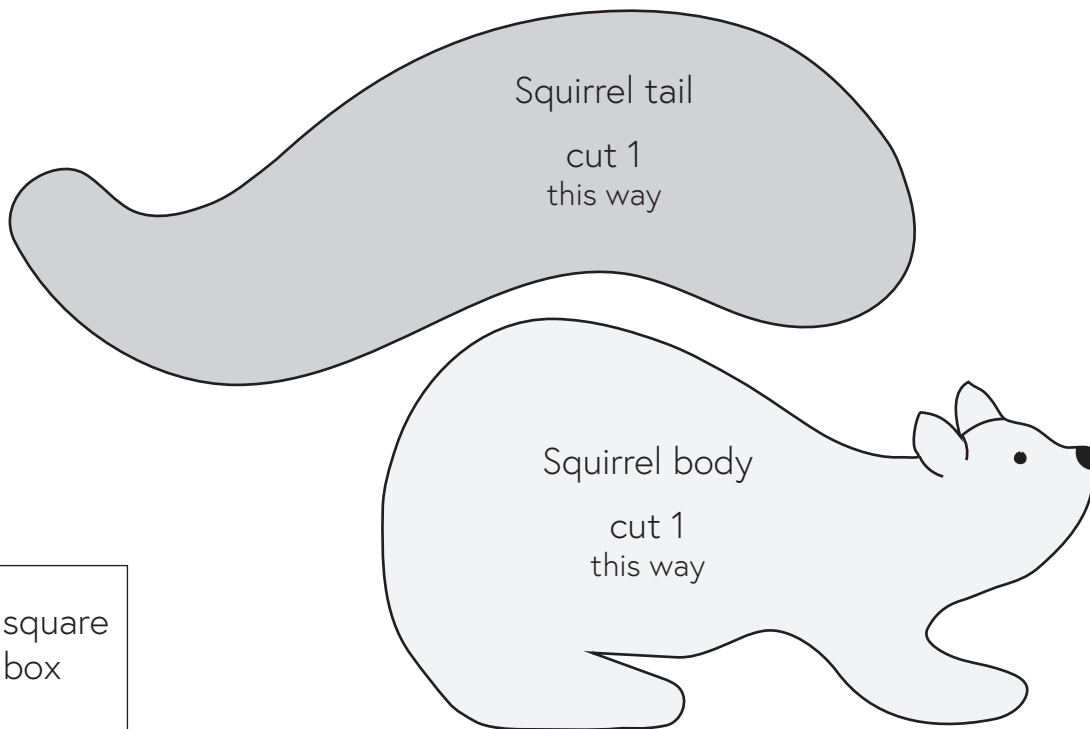

Skill level: confident beginner.

A great way to do some fun piecing and some raw edge applique.



Gourmet quilter
...because quilting is delicious!



A Walk in the Park

Approx. 59" x 67"

A Walk in the Park features
Hand-dyed Watercolors
by Hoffman Fabrics.

Fabric - based on fabric 42" wide	Fabric		Quilt approx. 59" x 67"
Light blue (1895 581-Bluegrass)	A	background patches, applique & border 2	2 yards (1.8m)
Medium blue (1895 550-Big Sur)	B	background patches & applique	1½ yards (1.5m)
Dark (1895 302-Stone)	C	border 1, binding & applique	1 yard (90cm)
Dark aqua (1895 467-Sea Cliff)	D	border 3 & applique	¾ yard (70cm)
Toast (1895 179-Toast)	E	tree trunks, branches & applique	¾ yard (70cm)
Biscuit (1895 563-Biscuit)	F	branches & applique	¾ yard (70cm)
Medium aqua (1895 247-Juneau)	G	applique	¾ yard (40cm)
Light green (1895 227-Sprout)	H	applique	¼ yard (25cm)
Dark grey (1895 173-Smoke)	J	applique	¼ yard (25cm)
Medium grey (1895 597-December)	K	applique	¼ yard (25cm)
Dark green (1895 141-Pine)	L	applique	¼ yard (25cm)
Light grey (1895 483-Fog)	M	applique	⅛ yard (10cm)
Paper-backed fusible web (based on web 36" wide)			1 yard (90cm)
Backing			67" x 85"
Batting			67" x 85"

Featuring fabric by *Hoffman*
CALIFORNIA INTERNATIONAL FABRICS

