

Hoffman

CALIFORNIA-INTERNATIONAL FABRICS

PALETTE of the Season







Whimsy & Wonder
designed exclusively for Hoffman Fabrics by
The Gourmet Quilter

Finished Size: 51" x 66"

FREESHOP-741-Whimsy







Whimsy & Wonder

There is quite a lot of cutting for this quilt, take your time and label the pieces as you go.

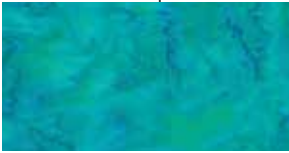
Cutting		Quilt measures approx. 51" x 66"	Label
Fabric A - Dark blue 	block backgrounds setting triangles sashing pieced block patches pieced block patches pieced block patches pieced block patches border 2 corners border 2 triangles border 2 triangles border 2 fill-ins applique shapes	6 x 10½" squares 2 x 15" squares cut diagonally twice  24 x 2½" x 10½" rectangles 6 x 2½" squares 6 x 2½" x 4½" rectangles 6 x 2½" x 6½" rectangles 6 x 2½" x 8½" rectangles 4 x 4½" squares 40 x tall triangles (see page 19 for template) 8 x tall half triangles (4 each way) 8 x 1½" x 4½" rectangles 2 x car windows	A1 A2 A3 A4 A5 A6 A7 A8 A9 A10 A11
Fabric B - Orange 	border 2 triangles roof wedges block patches sashing posts applique shapes	4 x tall triangles 5 x 3½" x 9" rectangles 3 x 2½" squares 2 x 2½" squares 1 x chicken head 1 x horse saddle strap 1 x car petal	B1 B2 B3 B4
Fabric C - Yellow 	border 2 triangles roof wedges sashing post applique shapes	4 x tall triangles 5 x 3½" x 9" rectangles 1 x 2½" square 1 x chicken body 5 x chicken tail feathers 1 x horse saddle strap 2 x car petals	C1 C2 C3
Fabric D - Light green 	border 2 triangles roof wedges sashing posts roof points applique shapes	6 x tall triangles 5 x 3½" x 9" rectangles 11 x 2½" squares 2 x 3¼" squares 1 x chicken body 1 x horse large saddle 1 x horse tail 2 x car petals 6 x poles - ¼" wide by approx. 6" long	D1 D2 D3 D4

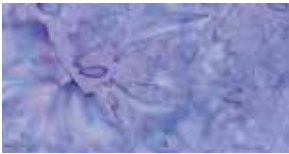
cutting continued on next page.....

Whimsy & Wonder

Cutting continued		Quilt measures approx. 51" x 66"	Label
Fabric E - Jade 	border 2 triangles roof wedges block patch & sashing post roof points applique shapes	4 x tall triangles 2 x 3½" x 9" rectangles 4 x 2½" squares 5 x ¾" squares 1 x chicken wing 1 x horse 1 x horse tail 1 x car 2 x wheel centres	E1 E2 E3 E4
Fabric F - Aqua 	border 2 triangles roof wedge block patches applique shapes binding	6 x tall triangles 1 x 3½" x 9" rectangle 3 x 2½" squares 1 x chicken wing 6 x 2½" strips, width of fabric	F1 F2 F3 F4
Fabric G - Purple 	border 2 triangles roof wedges applique shapes	4 x tall triangles 3 x 3½" x 9" rectangle 1 x horse mane 2 x car wheel centres	G1 G2
Fabric H - Light purple 	border 2 triangles roof wedge roof points applique shapes	4 x tall triangles 1 x 3½" x 9" rectangle 3 x ¾" squares 1 x chicken head 2 x chicken tails 2 x horse small saddle 1 x car 2 x car wheels	H1 H2 H3
Fabric J - Blue 	border 2 triangles sashing posts roof points border 1 sides border 1 top & bottom border 3 sides border 3 top & bottom	2 x tall triangles 2 x 2½" squares 3 x ¾" squares 3 x 2½" strips, width of fabric 2 x 2" strips, width of fabric 3 x 3" strips, width of fabric 3 x 2½" strips, width of fabric	J1 J2 J3 J4 J5 J6 J7
Fabric K - Pink 	border 2 triangles roof wedges roof points applique shapes	4 x tall triangles 2 x 3½" x 9" rectangles 5 x ¾" squares 5 x chicken feathers 1 x horse large saddle 1 x horse mane	K1 K2 K3
Fabric L - Fuschia 	border 2 triangles block patches roof points applique shape	4 x tall triangles 3 x 2½" squares 3 x ¾" squares 1 x car petal	L1 L2 L3

cutting continued on next page.....

Cutting		Quilt measures approx. 51" x 66"	Label
Fabric M - Raspberry 	border 2 triangles roof points block patches applique shapes	2 x tall triangles 3 x 3¼" squares 3 x 2½" squares 1 x horse 2 x chicken wattle/comb 2 x car wheels	M1 M2 M3
Paper-backed fusible web	applique shapes - horse applique shapes - chicken applique shapes - car applique shapes - all	2 each (1 each way) x horse, large saddle, small saddle, mane, tail, saddle strap 2 each (1 each way) x chicken head, comb/wattle, body, wing, tail, tail feathers 2 each (1 each way) x car, window, wheels, wheel centres, centre petal, side petals 6 x 1/4" wide strips as poles, approx. 6" long	
Backing		59" x 74"	
Batting		59" x 74"	

General Information

Patchwork piecing:

When piecing it is good to use a ¼" seam allowance throughout, unless otherwise mentioned. Here is a video to see how you can achieve a ¼" seam allowance: <https://youtu.be/bdzIMEqAAbc>

Press seams as you go. Generally it is a good idea to press towards the darker coloured fabric although there are times when it is better to press to suit the piecing. An example of this is where we are joining strips that are already pieced, it is helpful to have the seams going in opposite directions so that they nestle together nicely and don't create bumps. The seams are more likely to meet at the joins better this way.

I like to trim my threads as I go, some sewing machines do this quite nicely, however not all! I suggest you trim the threads about ¼" away from where the stitching finished so that it doesn't just unravel, the extra little bit is surprisingly helpful with this.

Enjoy the quilt!

General Information continued:

Applique:

The method I have used for the appliqué is as follows:

1. Iron the fabrics.
2. Trace the pattern pieces, using a pencil, on to paper-backed fusible webbing. The patterns are back to front because when you trace and use fusible web they will be reversed. The paper backed fusible webbing has glue on one side (rough texture) and is smooth on the other side. Trace on to the smooth side. Roughly cut out the pieces, not on the lines, and iron the glue side to the back side of the fabric pieces.
Now cut out on the lines, with the paper attached.
3. Wiggle the pieces a little, this should loosen the paper, peel the paper off (there should now be glue on the back side of the fabric) and position the pieces on to the background fabric. Iron in place.
4. For this quilt, a machine blanket stitch works well or free-motion straight stitch close to the edge. I use the same colour for all the applique stitching, usually a dark charcoal colour.
5. With the applique patterns there is a 1" scale guide included so that you can see if your patterns are printing the correct size, computers and printers often print a different size to the original.

For printing purposes, the paper size used is US Letter size, however the printer should be set to print "actual size" even if you are using a slightly different size paper.

Foundation piecing:

The roofs are foundation pieced, which means that the fabrics are stitched on to a foundation, in this case a paper foundation. The paper foundation patterns for the roofs are included in the pattern.

If you haven't done foundation piecing before, don't be afraid, just take it slowly and you will get into the rhythm of it.

It is a little like working back to front and you will be stitching through the paper, on the lines, as well as the fabric. Because we are working from the back, the block will end up mirror imaged from the way the pattern appears.

Use a shorter length stitch than usual, this helps to perforate the paper so it is easier to remove as well as adding a little extra strength because of the pulling of the paper during removal.

The pattern shapes are numbered in order of placement.

Piecing:

The quilt consists of blocks, some pieced and some appliqued, that are sashed and set on-point. The pieced blocks sit at the top of the quilt and will need to be trimmed later.

Make the pieced blocks:

There are 3 x pieced blocks.

Using pieces: **A4, A5, A6, A7, B3, L2, E3, M3 & F3.**

Looking at the diagram of the block, join the patches together.

All 3 blocks are the same.

The blocks measure 10½" square.

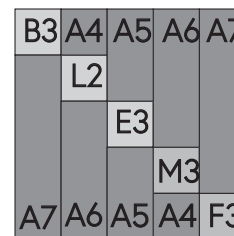

Make the foundation pieced roofs: (please read the general Information for Foundation Piecing)

There are 6 x foundation pieced roofs. The method is shown for one roof.

Using pieces: **B2, C2, D2, E2, F2, G2, H2 & K2.**

A lightbox or light source (such as a window) will help with positioning the fabric.

Start by placing piece **B2** right side down on a surface.

Then place the foundation pattern piece, printed side up, on top.

Using a light source to help with positioning, place piece **D2** underneath **B2**, right sides together, so that the edge is parallel to the first stitching line.

The edge should sit at least ¼" past the line. Stitch along the line extending the stitching into the seam allowance area.

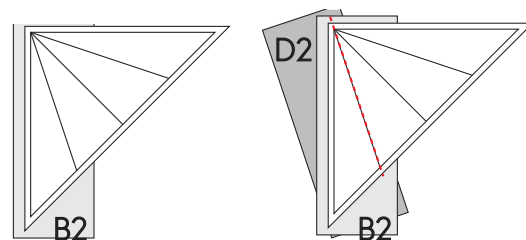

Fold back the paper along the stitching line so that the excess fabric (to the right of the stitching line) is exposed.

Trim the seam allowance to ¼", running parallel to the stitched line.

Fold the paper back so it sits flat again. Fold out and press **D2**.

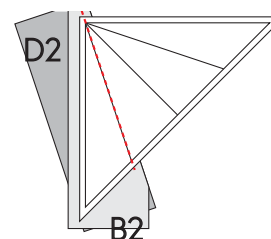

Continuing on in the same manner, position piece **E2**, stitch along the second line, fold back the paper, trim the seam, lay the paper flat again. Fold out and press **E2**.

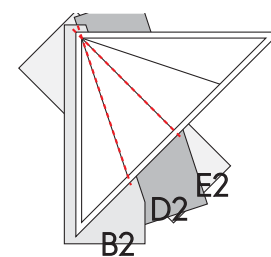

Repeat the method with piece **C2**.

When all the pieces are attached to the paper and pressed, trim all the way around along the dotted line.

Make 6 x roofs in this manner, using the picture of the quilt to help with colour placement.

This is the routine I use for this type of foundation piecing: position, stitch, fold, trim, flip, repeat. Trim all round.

The paper needs to be removed - take care not to pull away any stitching, it may be helpful to give the paper a light mist of water to help soften it.

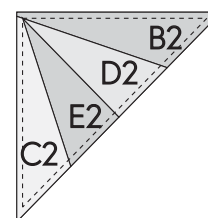

Make the roof points:

The roof points are folded triangles, adding a little 3-D fun to the quilt.

Using pieces **D4, E4, H3, J3, K3, L3 & M2**.

Place the square right side down, fold up half way and press.

Fold the 2 lower corners up to the centre and press. The folded triangle should look like this however it is turned over so there is no fold line showing on the right side.

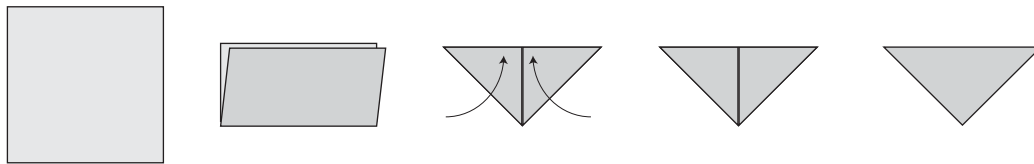

Position the roof points:

Position the roof points so the raw edges are even, right sides together along the lower edge of the roof.

Stitch in place using a slightly less than $\frac{1}{4}$ " seam allowance.

Do this to all 6 roofs.

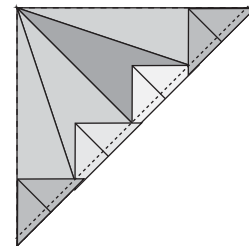

Attach the roof to the block background - A1:

Position the roof and points right sides together with **A1**.

The corners of the roof intersect $2\frac{1}{4}$ " from the edge of **A1**.

Trim away the corner of **A1**. Press the roof up with the points facing down.

Do this to all 6 roofs and **A1**.

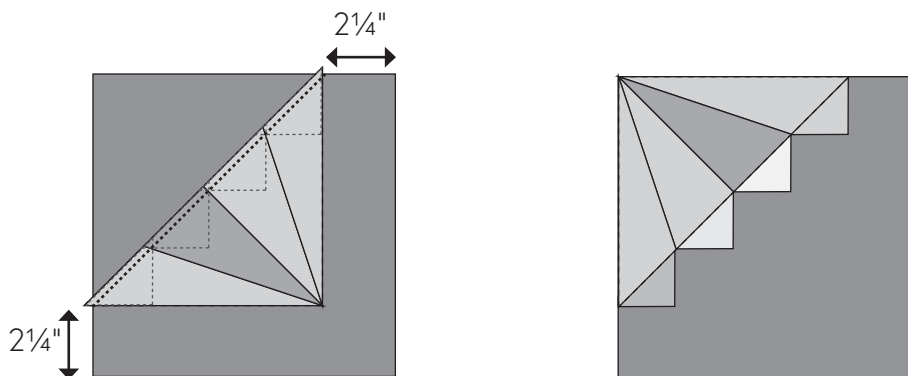

Add the sashing and posts:

At this stage it is easier to add the sashing and posts to the lower 2 sides of the blocks as they sit on-point (diagonally) as the applique sits over some of the seams. Sashings can also be added to the pieced blocks.

Join together a sashing post and sashing rectangle - look at the picture of the quilt for colour placement. Attach a sashing to the left lower side (as you look at it) and then attach the sashing/post to the other lower side.

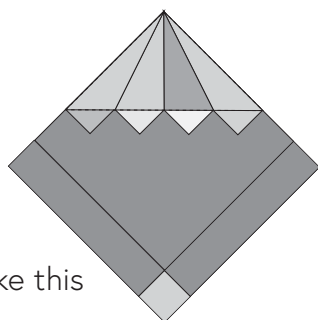

Make 6 like this

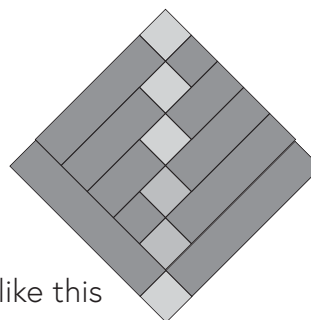

Make 3 like this

Applique: (please read the general Information for Applique)

Position the shapes on the blocks.

Start with the poles, these sit in the centre of the block, down from the roof.

Flip back the roof points and position the pole close to the seam - iron in place

Position the shapes so they sit over the poles - the shapes are numbered in the order of placement.

Iron the shapes in place.

Applique stitch around the shapes.

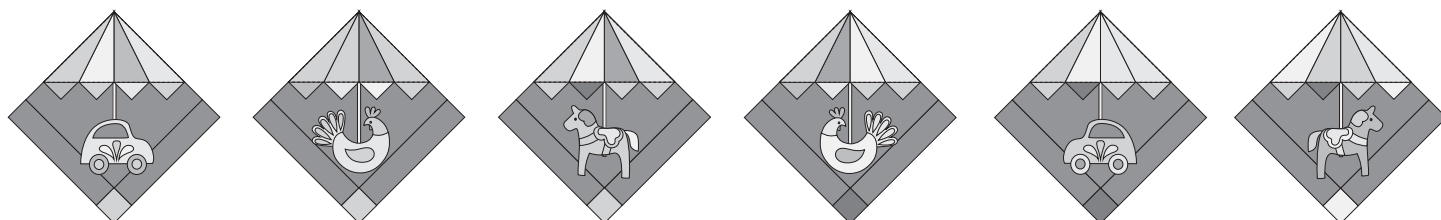

Joining up the quilt:

Looking at the diagram on Page 10, add the remaining sashing and posts to the **A2** setting triangles.

Join the blocks and setting triangles together - they go together well as diagonal rows.

Looking at the diagram on page 10, trim away around the edges of the quilt top.

The cutting line should be $\frac{1}{4}$ " away (to the outside) from the seam points so there is enough left to allow for a $\frac{1}{4}$ " seam all around.

This means that some of the sashing posts will be trimmed and the top part of the pieced blocks.

Adding the top corner patches:

Fold 2 x **D3** sashing posts in half diagonally.. Open them out and position one on each top corner of the quilt. Stitch along the diagonal line. Press the triangle so it sits in the top corners of the quilt top.

Add the borders: (see diagram on next page)

Border 1:

Join the border **J4** strips together into one long length.

Measure the length of the quilt, in 3 separate places, take an average of the 3 measurements and cut the 2 side borders that length.

Attach the 2 sides, press the seams into the border.

Using the **J5** strips, measure again the same way across the quilt, including the added side borders, cut the top and bottom borders that length. Attach the top and bottom borders and press.

Border 2:

Using pieces: **A8, A9, A10, A11, B1, C1, D1, E1, F1, G1, H1, J1, K1, L1 & M1.**

Make the 4 x border sides:

Starting and finishing each side with an **A10** and alternating an **A9** with the colours, join the four sides into rows.

The top and bottom rows each have 9 coloured triangles.



The sides each have 13 coloured triangles.



The border rows may need little a little adjustment so measure the length of the quilt, in 3 separate places, take an average of the 3 measurements - this is how long the side borders should be.

If the borders are a little short, and they could be, use the **A11** pieces at each end, trim as necessary. Set aside while you measure the width.

In the same manner, measure the width of the quilt and attach **A11** and trim as necessary. Attach the **A8** corner squares to each end.

Attach the 2 sides, press the seams into the previous border.

Attach the top and bottom, press the seams into the previous border.

Border 3:

Join the border **J6** strips together into one long length.

Measure the length of the quilt, in 3 separate places, take an average of the 3 measurements and cut the 2 side borders that length.

Attach the 2 sides, press the seams into the border.

Join the border **J7** strips together into one long length.

Measure again the same way across the quilt, including the added side borders, cut the top and bottom borders that length. Attach the top and bottom borders and press.

All the borders are on!

Whimsy & Wonder

This diagram shows the trimming line for the main part of the quilt and the top corner triangles to be added after trimming as well as the borders to be added.

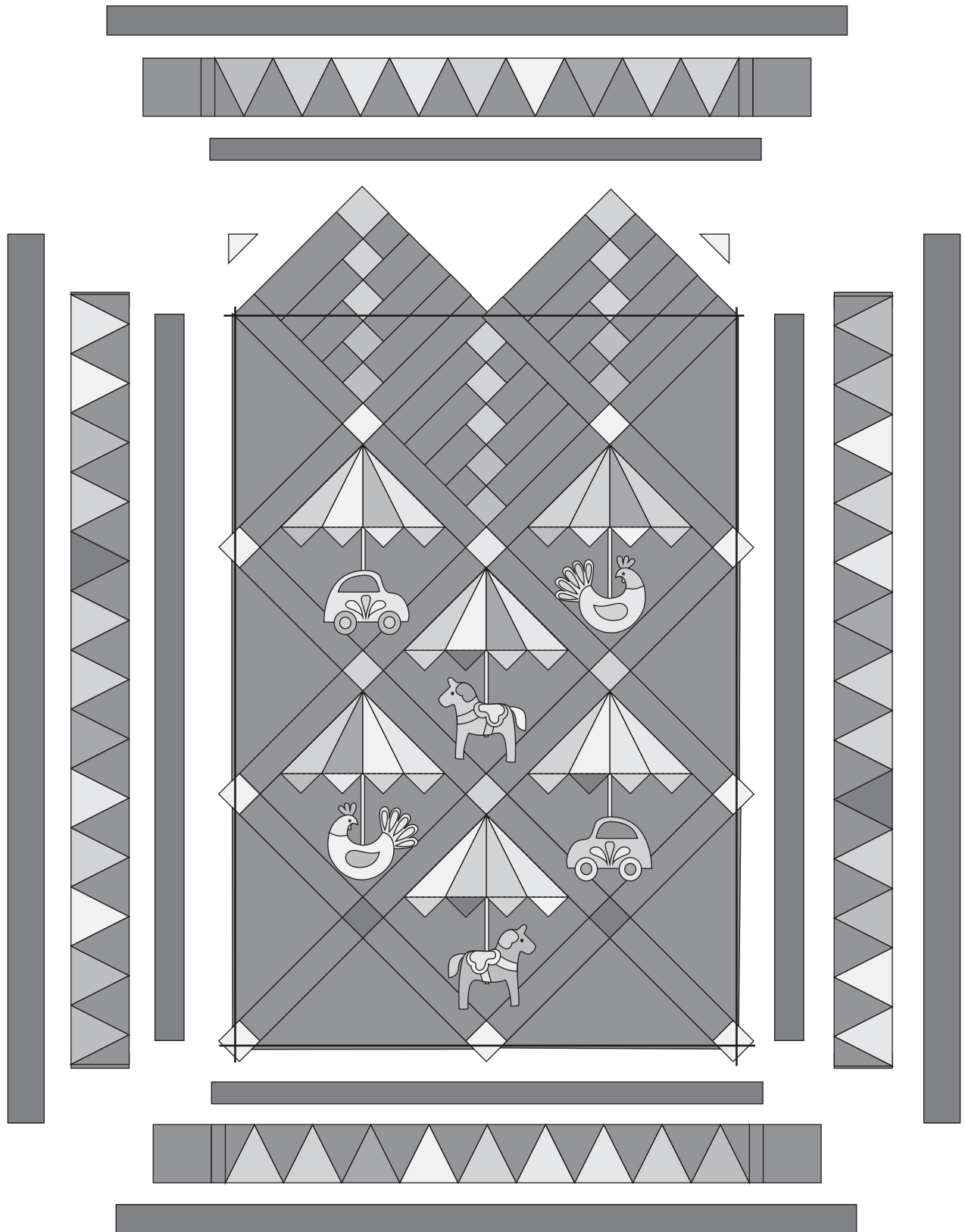

Whimsy & Wonder

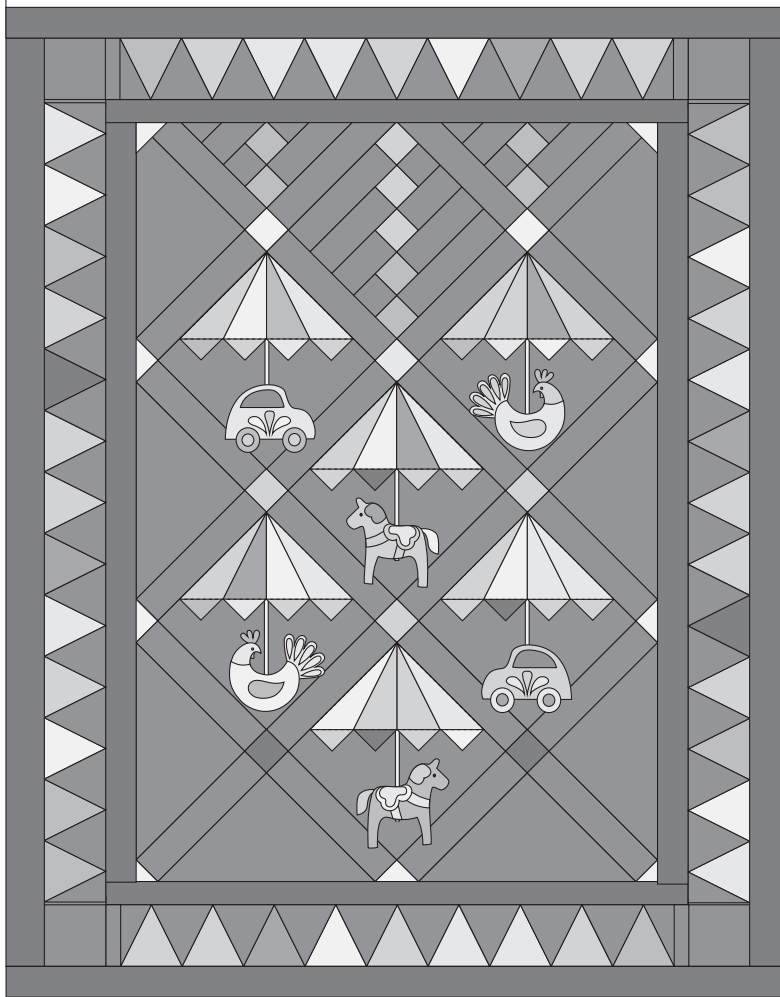

This means the quilt top is now finished! Now for some quilting!

Layering and Basting:

The backing and batting should be larger than your quilt top, maybe allow about 4" all round. Layer the quilt backing, batting and quilt top and baste ready for quilting. If you are using safety pins for basting, they should be approximately 4" apart, all over the quilt.

Quilt the quilt.

An all over free-motion quilting design works well.

However, you may prefer to use a walking foot to do straight lines, or do a different style of quilting! The straight lines can be stitched just a little away from the seam lines, or applique, approximately $\frac{1}{8}$ " - $\frac{1}{4}$ " away.

The quilt should have a fairly even amount of quilting all over to allow it to sit well.

Trim the edges of the batting and backing level with the edge of the quilt top.

The quilt is now ready for binding.

Whimsy & Wonder

Binding:

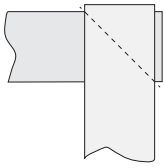

1. Join the binding strips, right sides together, diagonally into one long strip.

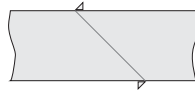

2. Press the seams open and trim away the little ears.

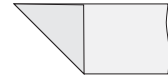

3. Trim the selvedge away and press the corner to the wrong side so the raw edges are level.



4. Fold the binding in half along the length, wrong sides together.

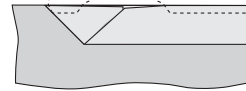

5. ******(see below) Attach the binding to the front of the quilt, raw edges even, using a $\frac{1}{4}$ " seam allowance. Starting along one side, from the point of the binding edge, stitch along for approx. 1" then stop and finish off.

Start stitching again approx. 3" further along.

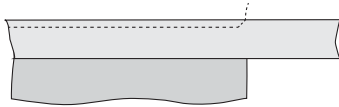

6. To form a mitred corner in the binding, stop stitching $\frac{1}{4}$ " before the end of the side and stitch diagonally out through the corner. Remove quilt and clip threads.

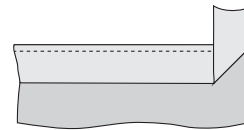

7. Turn the quilt so that it is ready to stitch the next side, fold back the binding diagonally away from you, so that the diagonal fold goes through the corner of the quilt.

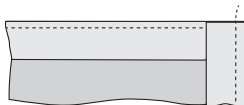

8. Fold the binding down towards you so that the folded edge is even with the edge of the quilt. Stitch from the folded edge along the side of the quilt.

Repeat this process at each corner.

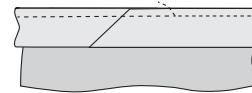

9. When you arrive at the starting point, trim the excess binding away, allowing enough to tuck inside the open end and stitch along until you meet the starting stitching.

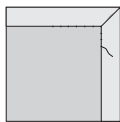

10. Fold the binding to the back of the quilt and slip stitch in place. The folded edge should just cover the machine stitched line. The corners should be folded into mitres and stitched in place.

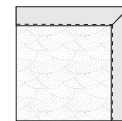

****** If you would prefer to attach your binding entirely by machine, start off by stitching the binding to the back of the quilt and continue as above. Fold the binding to the front of the quilt and machine stitch in place, stitching close to the folded edge of the binding.

Congratulations! You have finished your Whimsy & Wonder quilt!

Whimsy & Wonder

Whimsy & Wonder Applique shapes

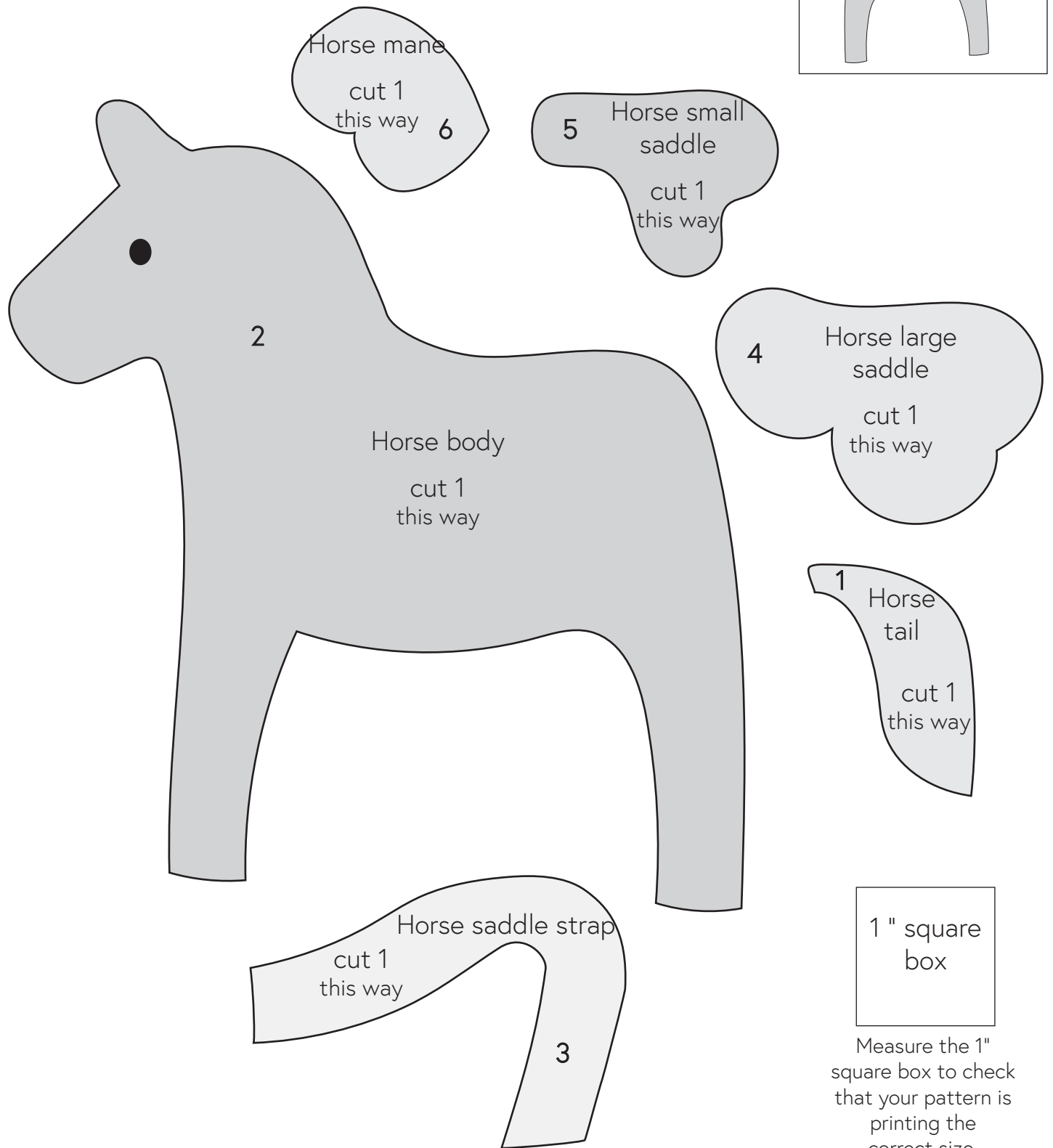
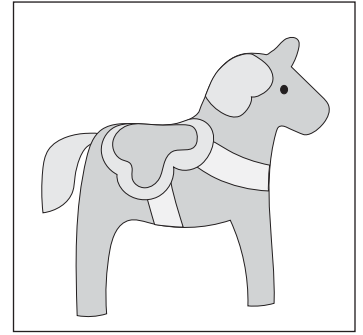

Whimsy & Wonder Applique shapes

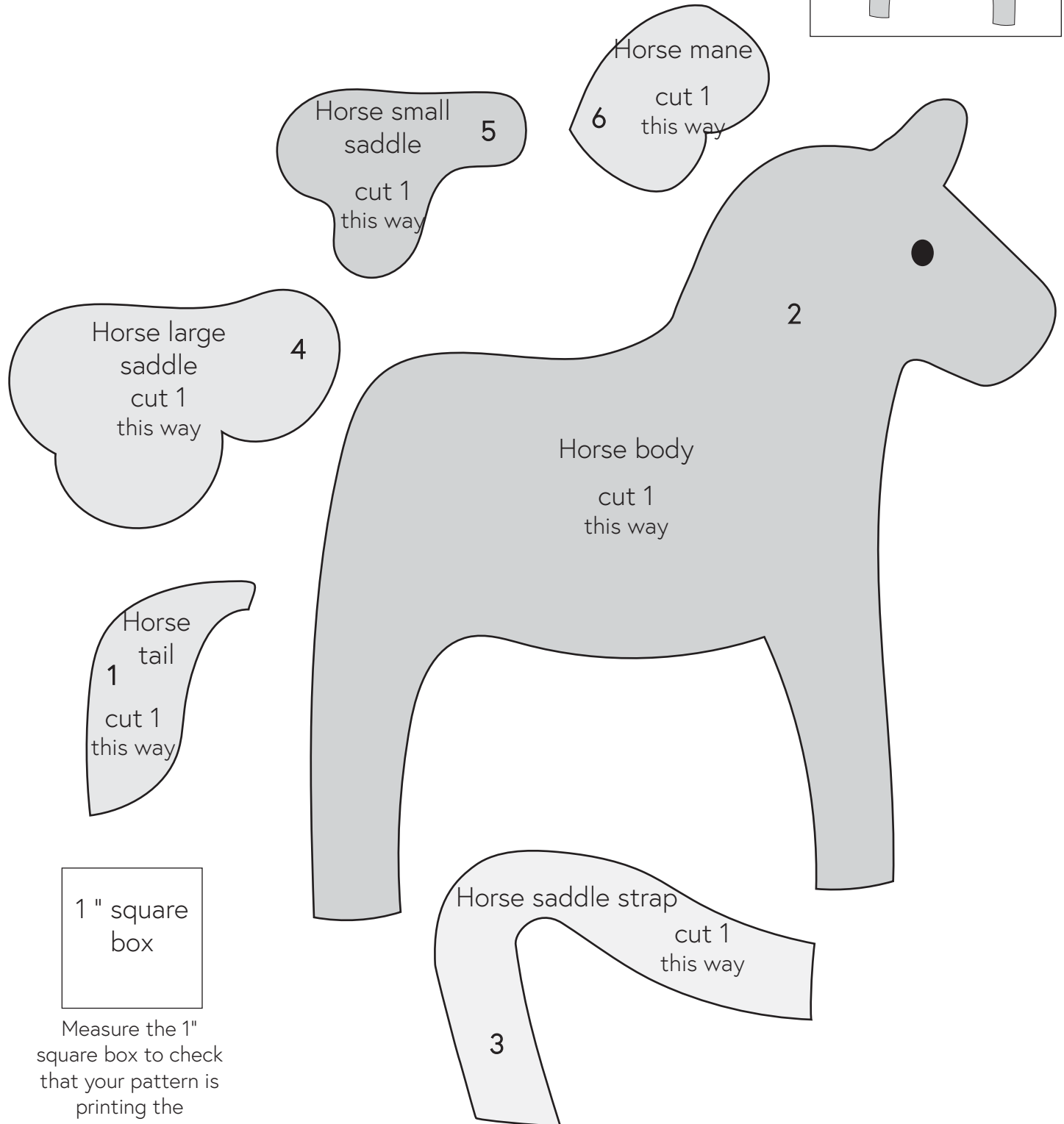
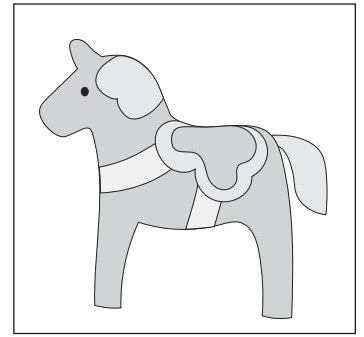

Measure the 1"
square box to check
that your pattern is
printing the
correct size.

Whimsy & Wonder

Whimsy & Wonder Applique shapes

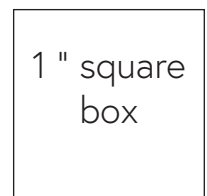
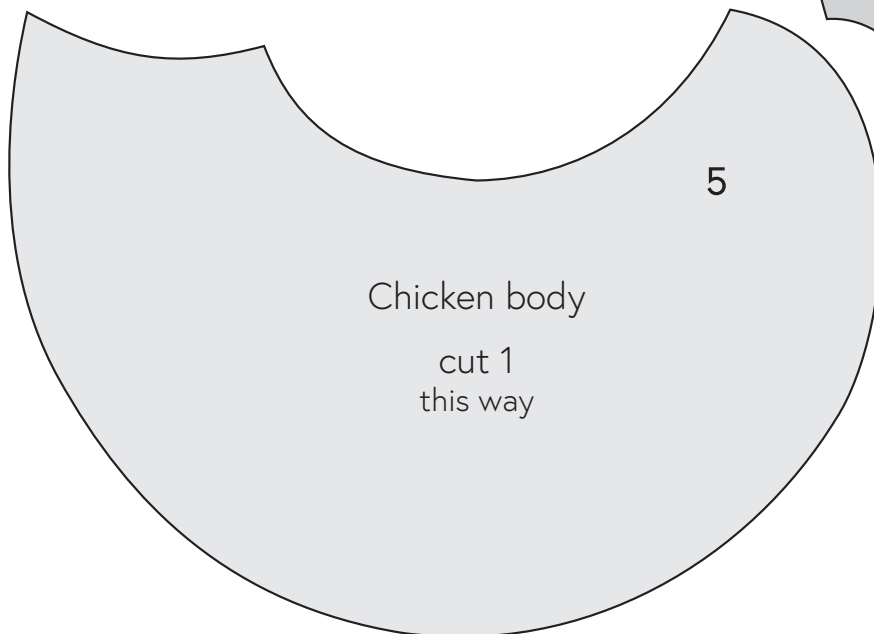
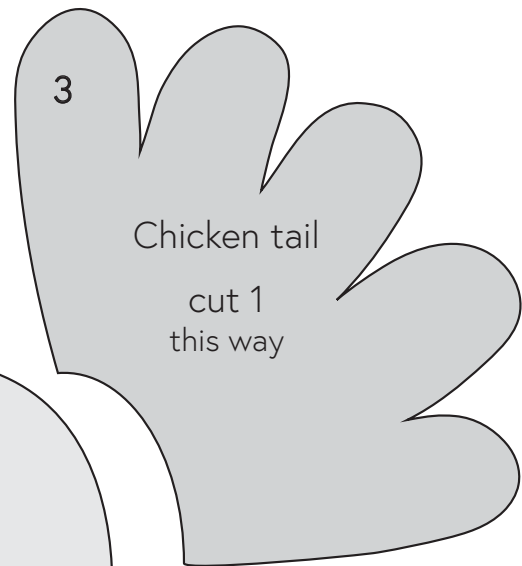
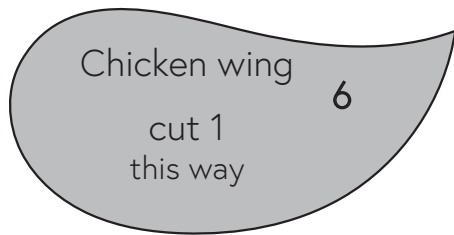
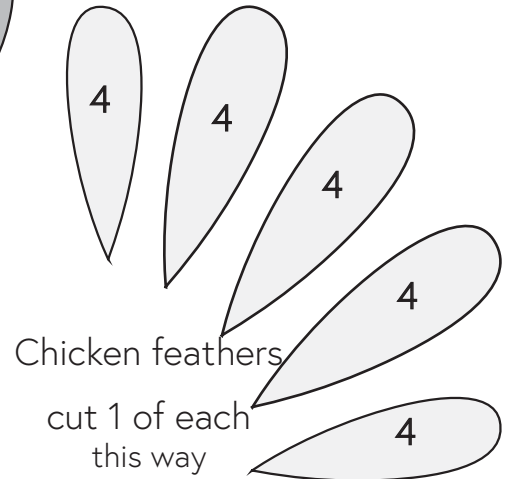
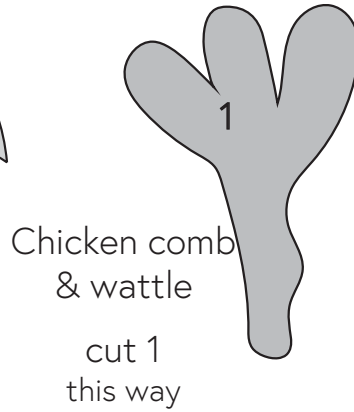
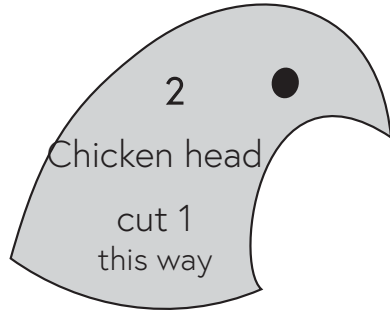
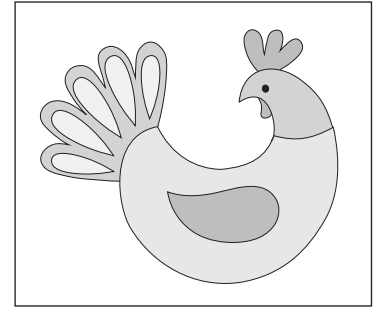

1" square box
Measure the 1" square box to check that your pattern is printing the correct size.

Whimsy & Wonder Applique shapes

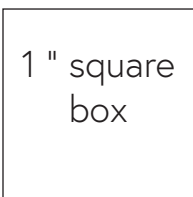
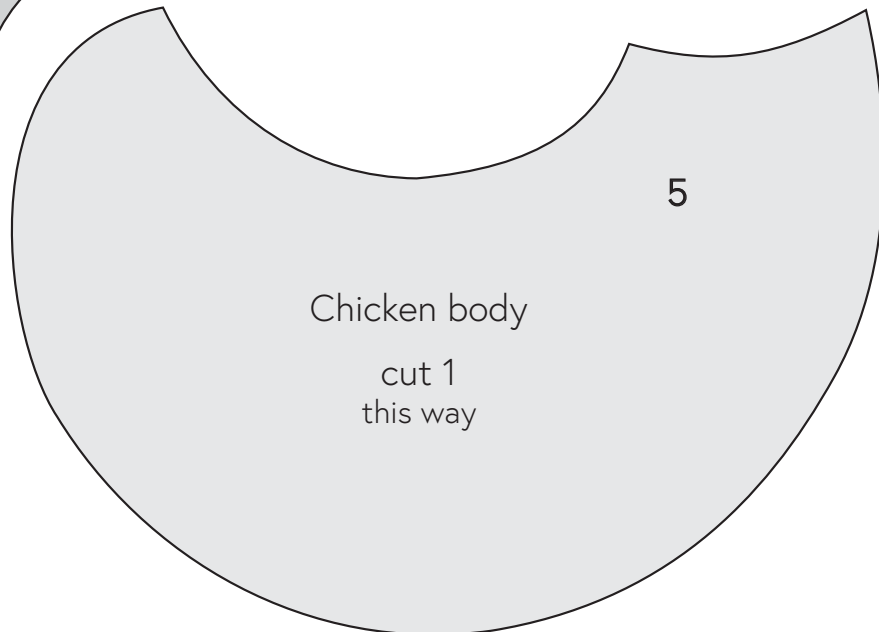
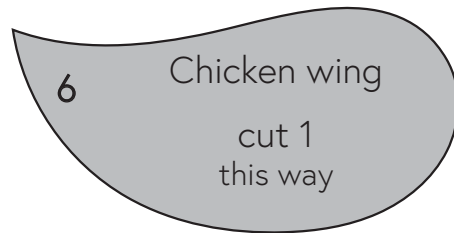
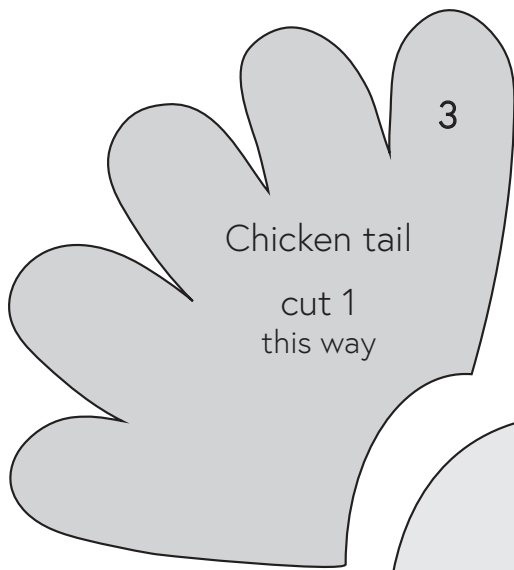
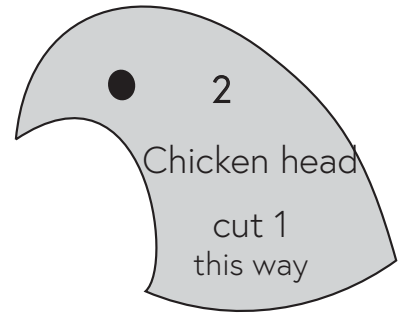
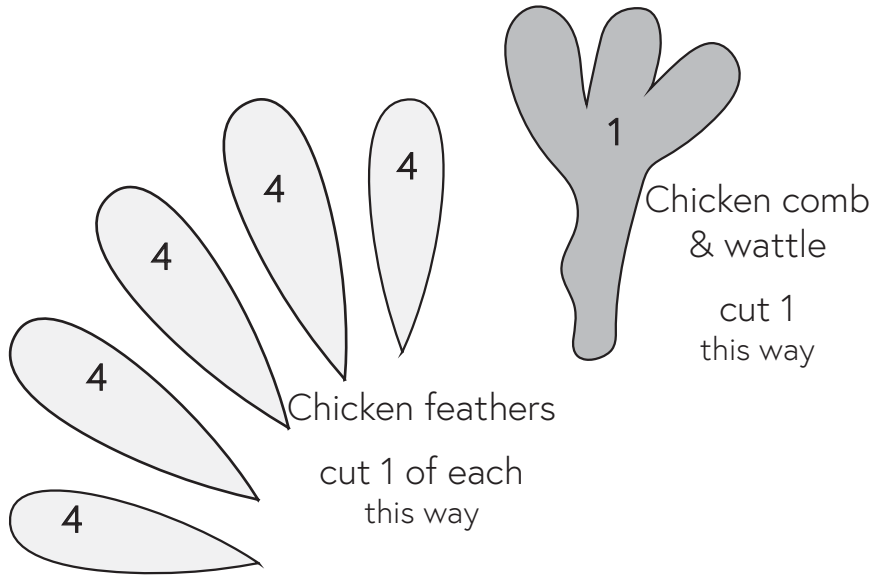
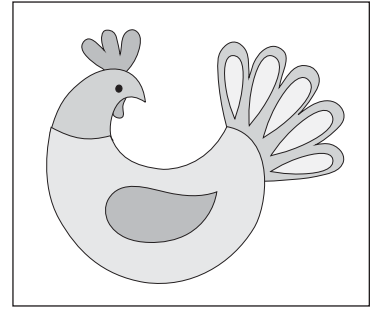

1 " square
box

Measure the 1"
square box to check
that your pattern is
printing the
correct size.

Whimsy & Wonder Applique shapes

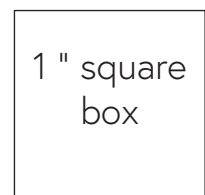
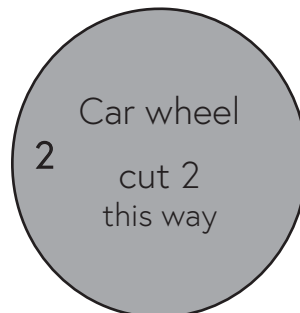
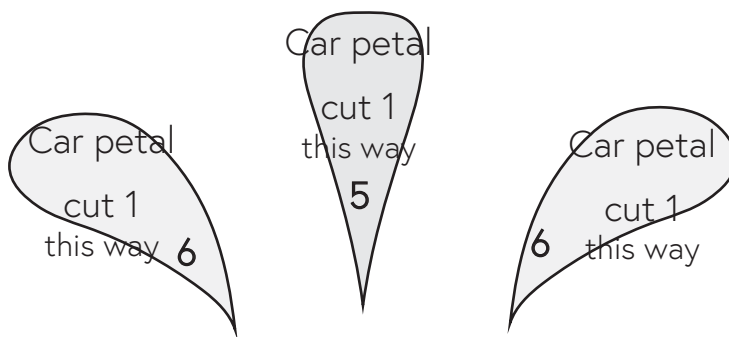
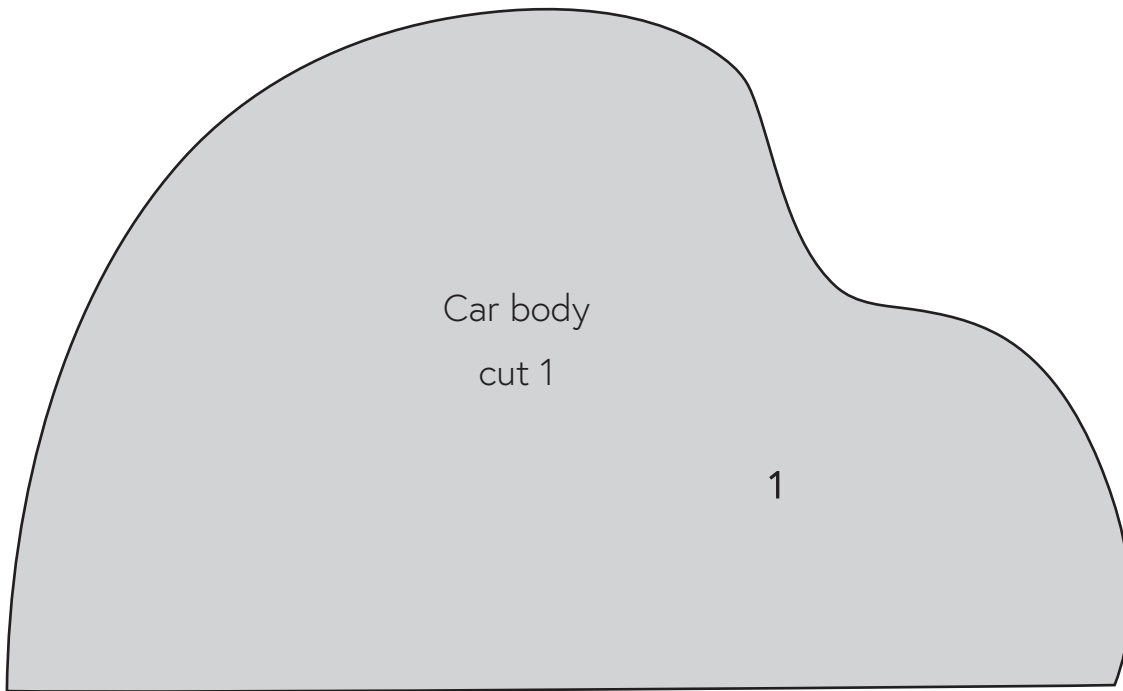
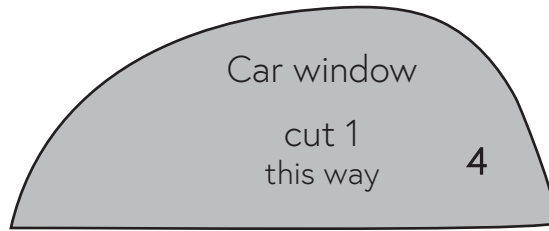
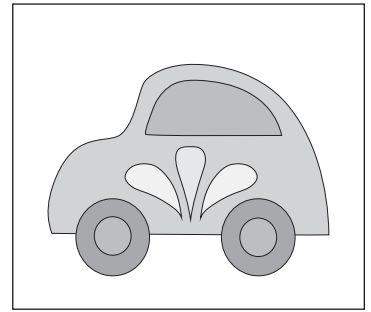

Measure the 1" square box to check that your pattern is printing the correct size.

Whimsy & Wonder Applique shapes

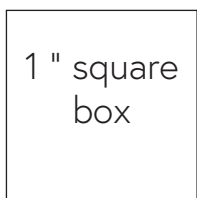
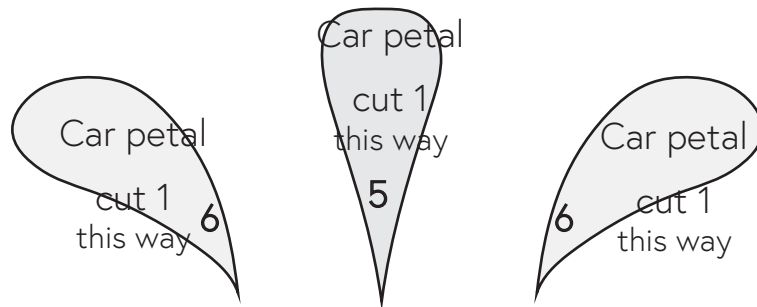
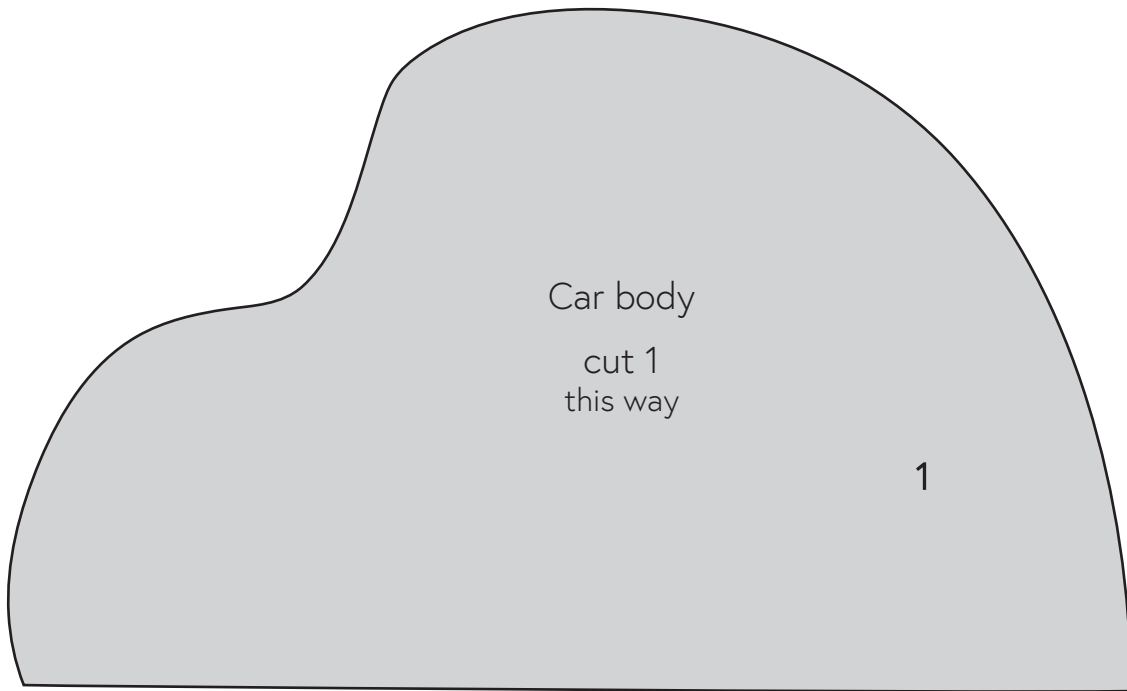
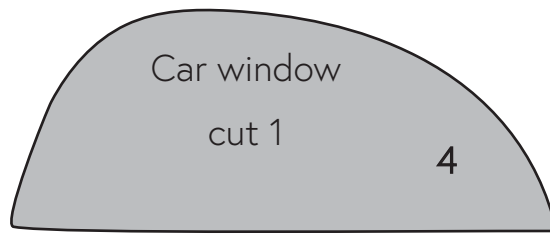
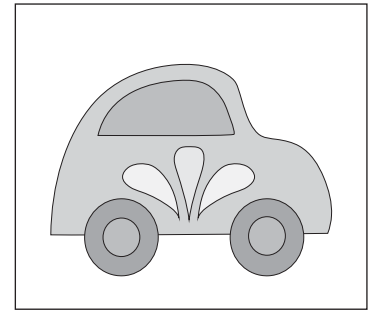

Measure the 1" square box to check that your pattern is printing the correct size.

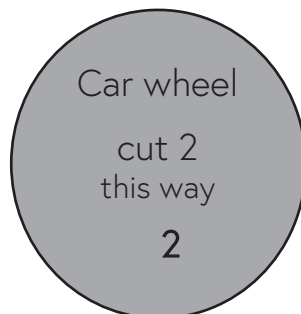

Triangle Border 2

Triangle shapes can be cut along a 4½" wide fabric strip, top and tail along the strip.

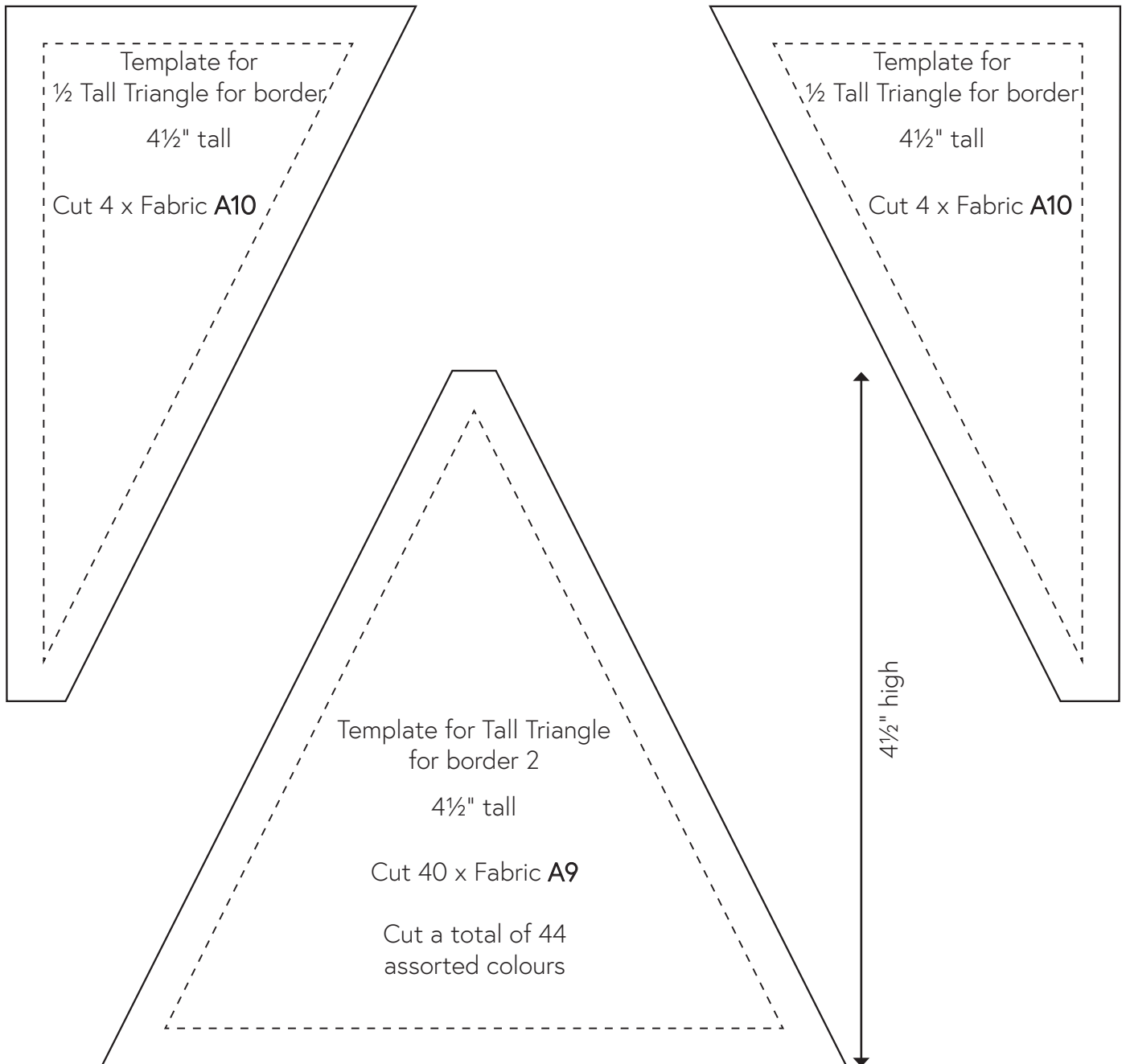
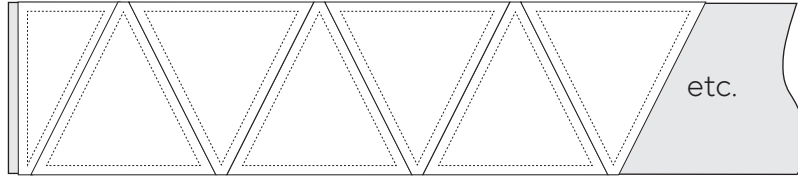

Roof Foundation

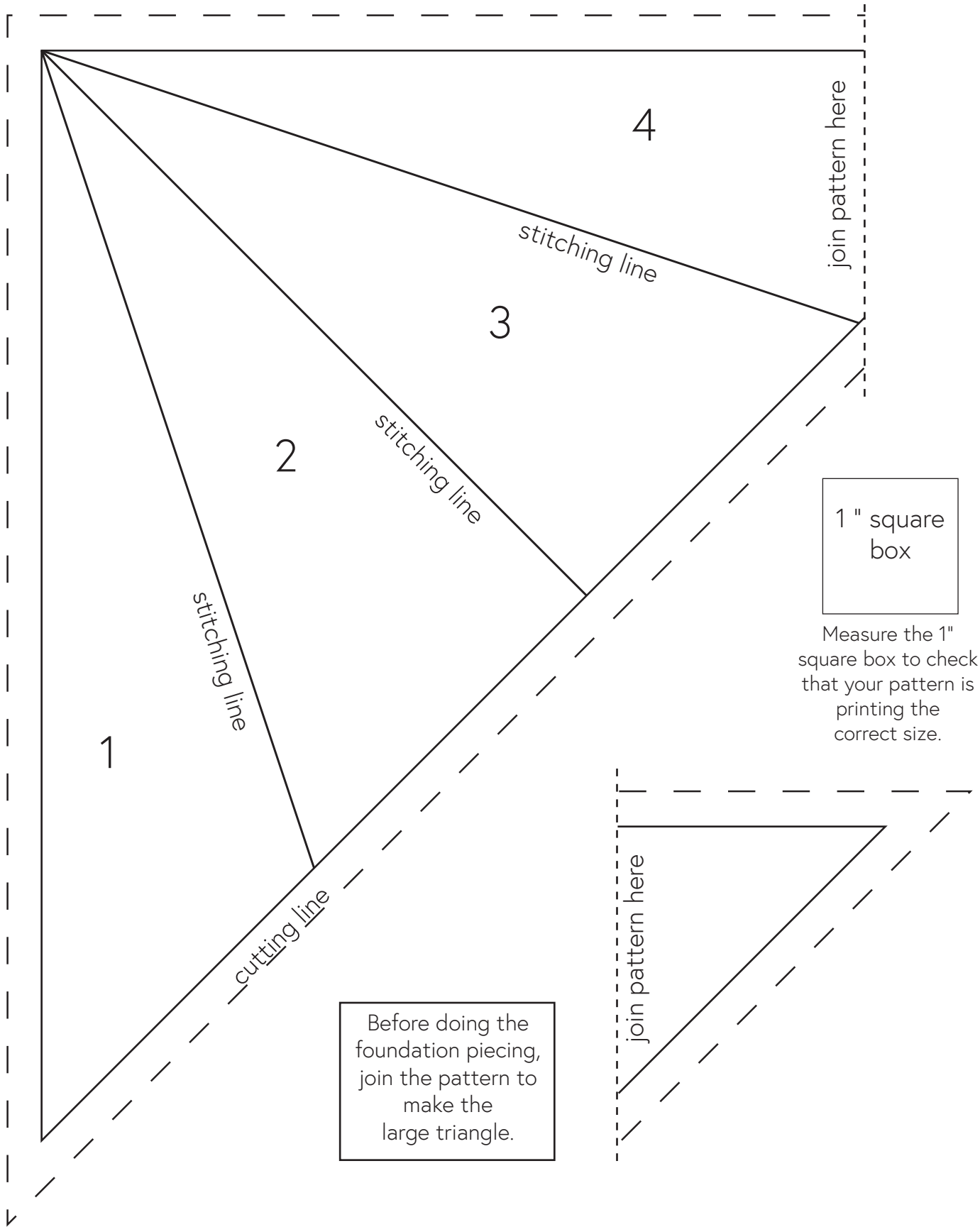

Roof Foundation

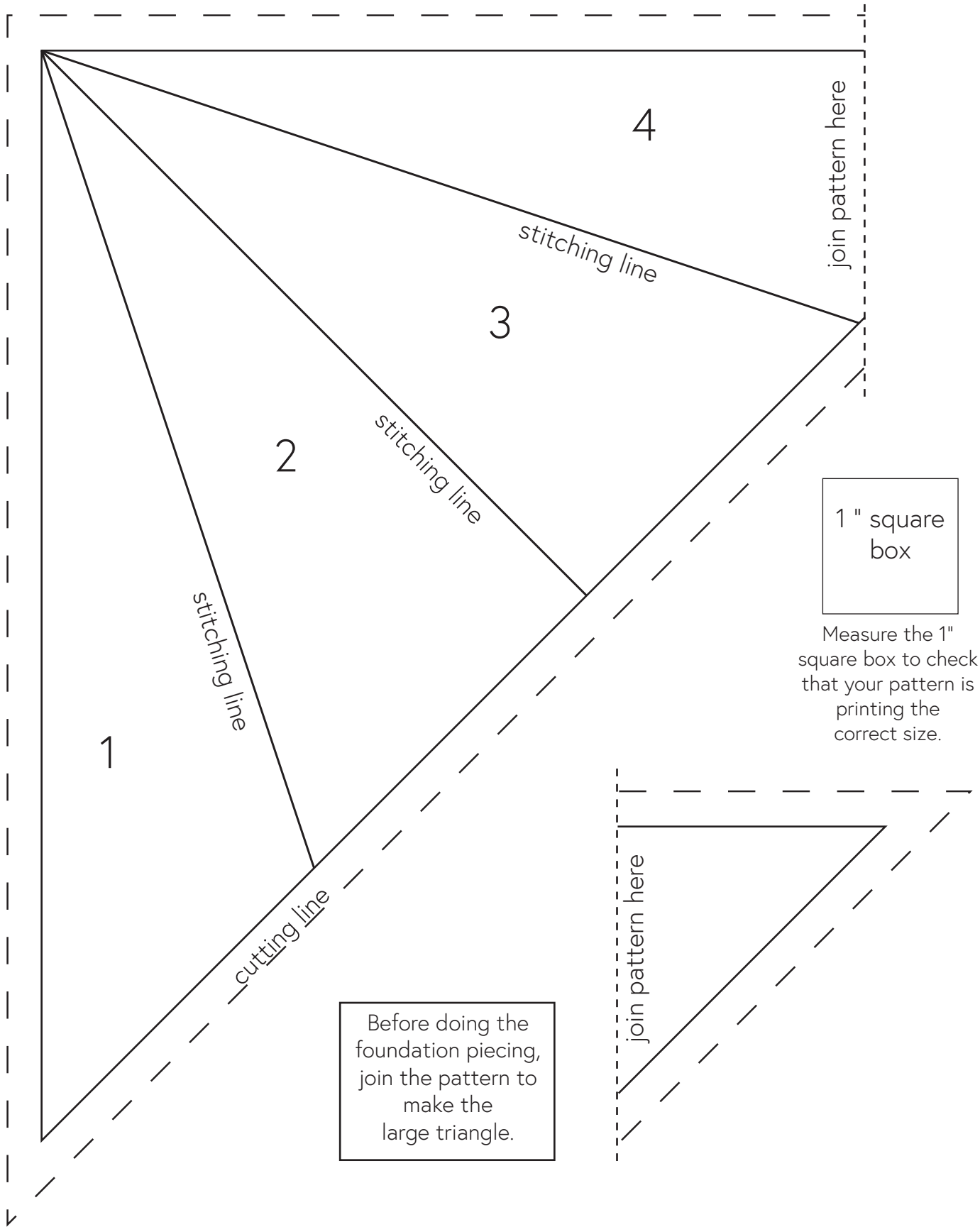

Roof Foundation

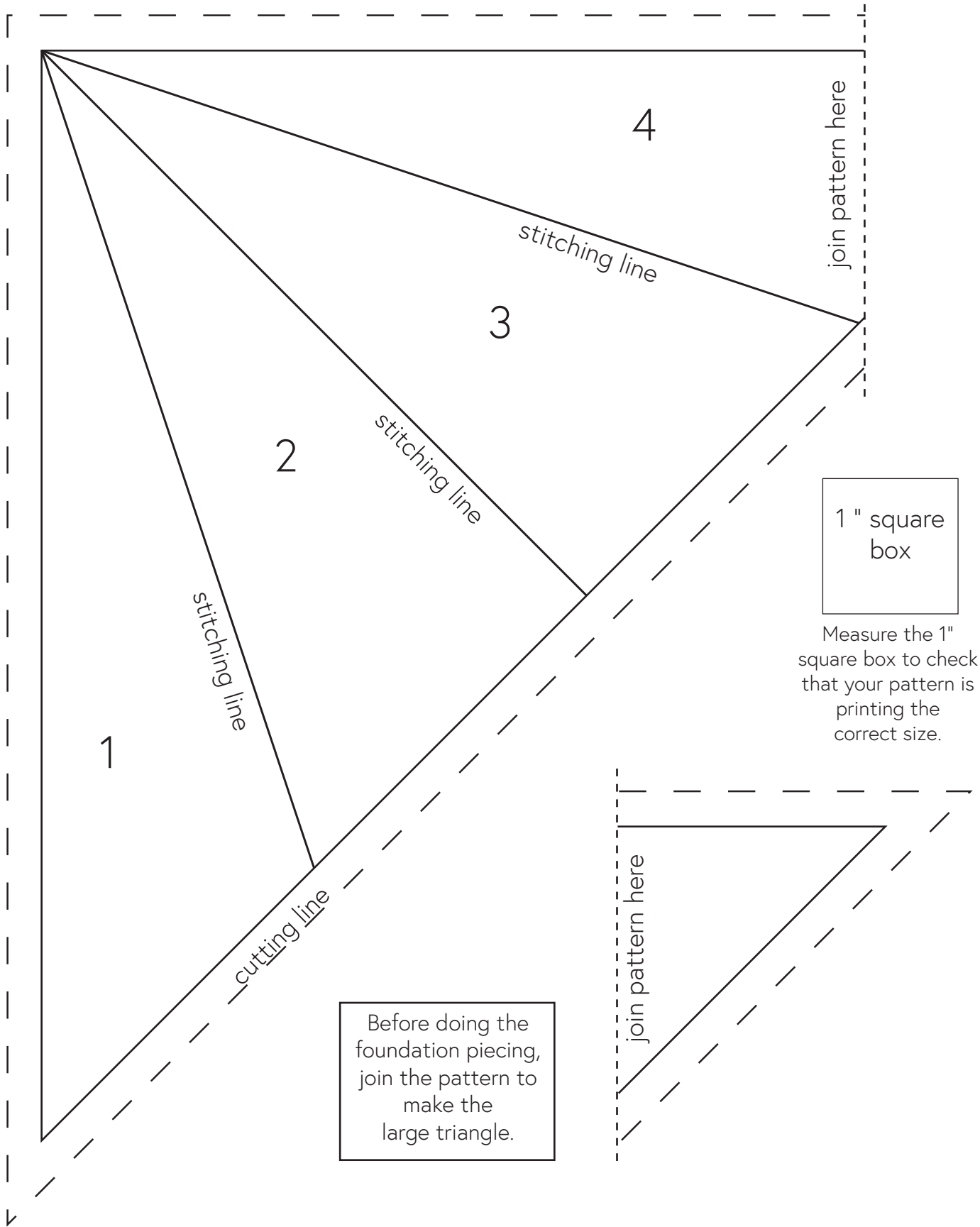

Roof Foundation

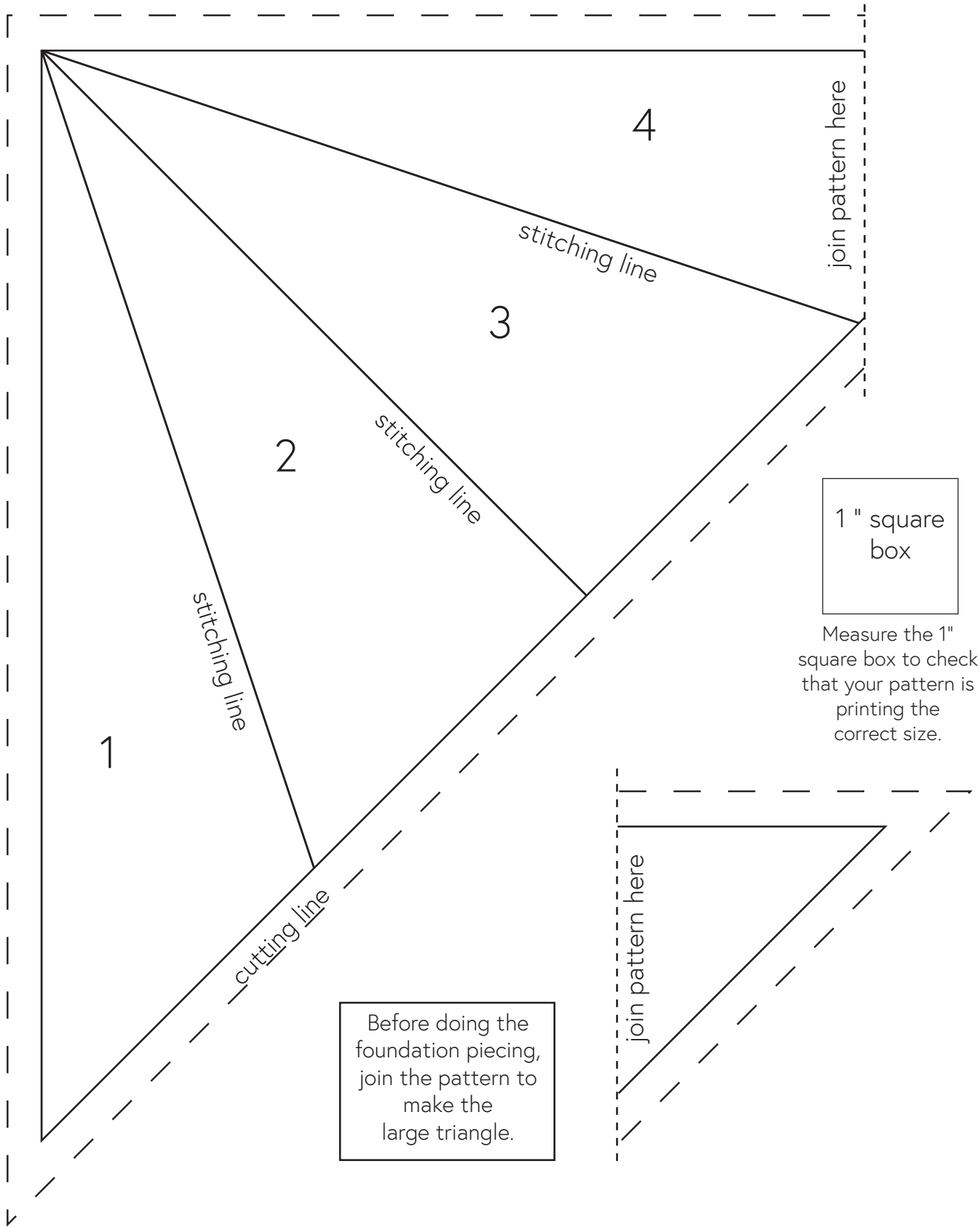

Roof Foundation

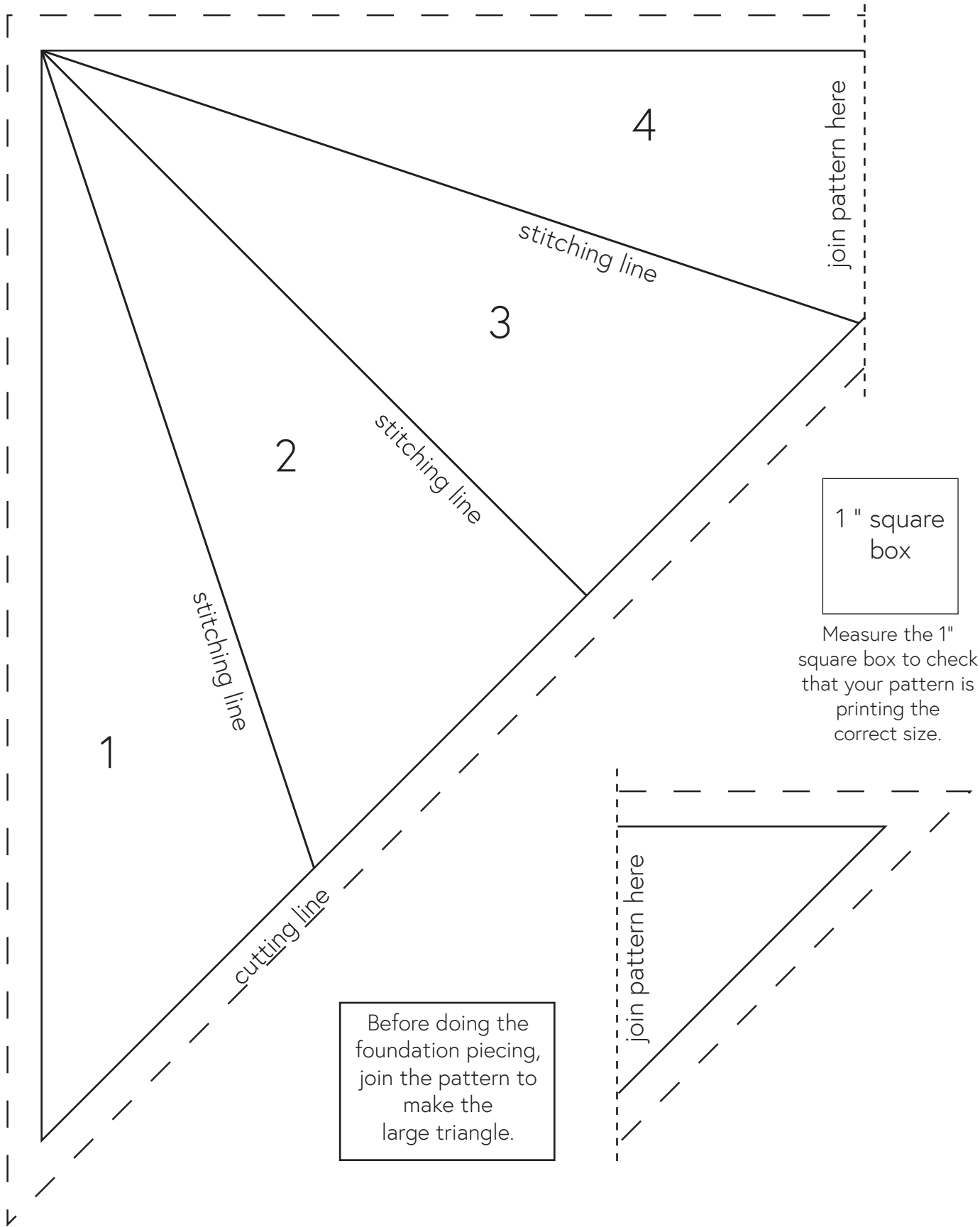

Roof Foundation

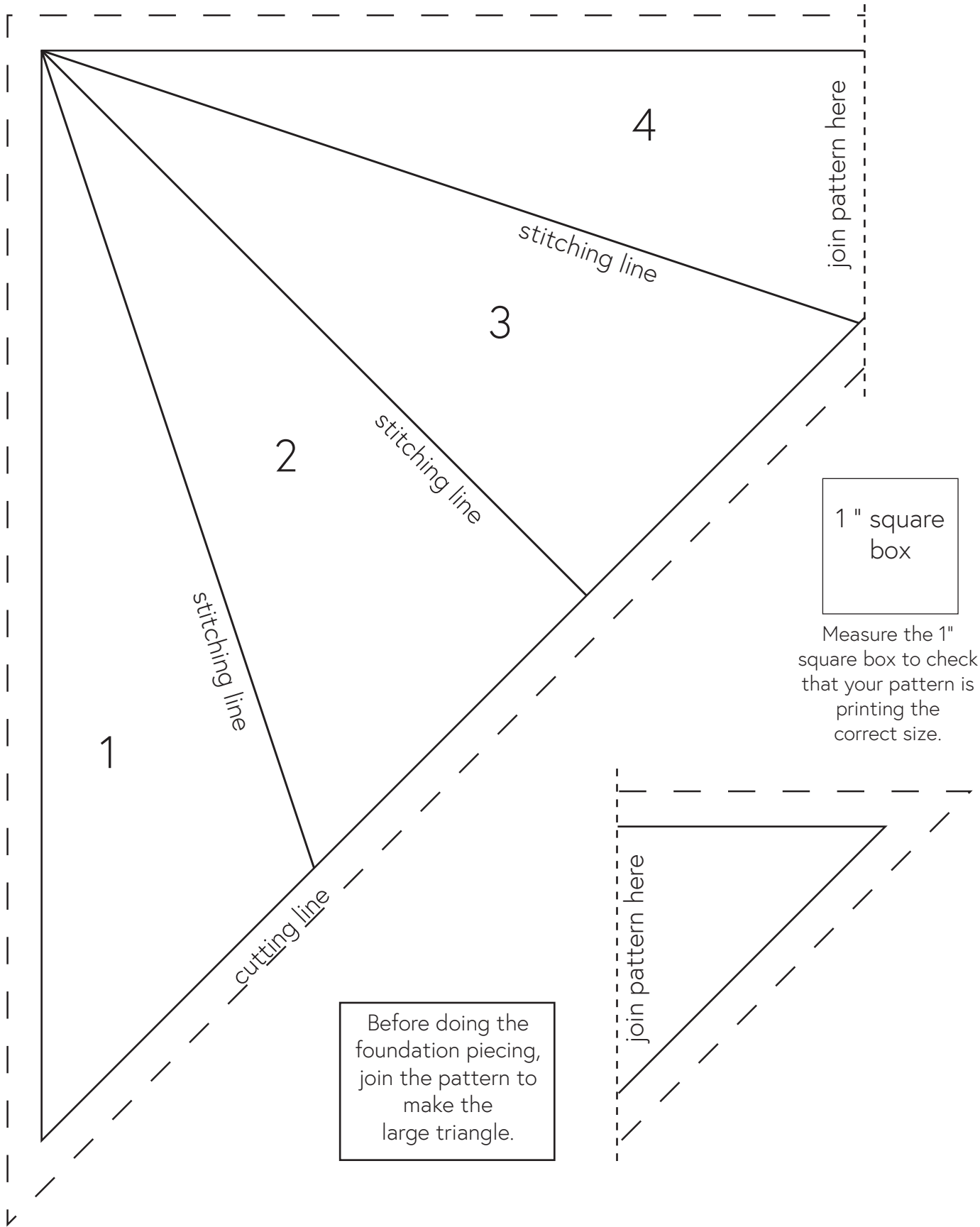

Skill level: confident beginner.

A great way to do some fun piecing, a small amount of foundation piecing and some raw edge applique.



Gourmet quilter
...because quilting is delicious!



Whimsy & Wonder

Approx. 51" x 66"

Whimsy & Wonder features
Hand-dyed Watercolors
by Hoffman Fabrics.

Fabric - based on fabric 42" wide	Fabric		Quilt approx. 51" x 66"
Dark blue (1895-524 Moonstruck)	A	background patches & border 2	3 yards (2.7m)
Orange (1895-689 Cantaloupe)	B	patches & applique	3/8 yard (40cm)
Yellow (1895-593 August)	C	patches & applique	3/8 yard (40cm)
Light green (1895-680 Honeydew)	D	patches & applique	5/8 yard (60cm)
Jade (1895-29 Jade)	E	patches & applique	1/2 yard (50cm)
Aqua (1895-322 Betta Fish)	F	patches, applique & binding	3/4 yard (70cm)
Purple (1895-598 New Years)	G	patches & applique	3/8 yard (40cm)
Light purple (1895-477 Shaved Ice)	H	patches & applique	1/2 yard (50cm)
Blue (1895-332 Julie)	J	patches, applique & Borders 1 & 3	1 1/4 yards (1.2m)
Pink (1895-519 Hibiscus)	K	applique	1/2 yard (50cm)
Fuschia (1895-23 Fuschia)	L	applique	3/8 yard (40cm)
Raspberry (1895-97 Raspberry)	M	applique	3/8 yard (40cm)
Paper-backed fusible web (based on web 36" wide)			1/2 yard (50cm)
Backing			59" x 74"
Batting			59" x 74"

A permanent marking pen or embroidery thread for the eyes.

Featuring fabric by 

